

132747



KINNETO

OWNER'S MANUAL SUPPLEMENT

cannondale

About This Supplement

Cannondale Owner's Manual Supplements provide important model specific safety, maintenance, and technical information. They are not replacements for your Cannondale Bicycle Owner's Manual. This supplement may be one of several for your bike. Be sure to obtain and read all of them.

If you need a manual or supplement, or have a question about your bike, please contact your Cannondale Dealer immediately, or call us at one of the telephone numbers listed on the back cover of this manual. You can download Adobe Acrobat PDF versions of any Cannondale Owner's Manuals or Supplements from our website: <http://www.cannondale.com/>.

Please note that the specifications and information in this manual are subject to change for product improvement. For the latest product information, go to <http://www.cannondale.com>.

Online E-Series Product Support

You may download a copy of this supplement and other manuals and instructions available for your bike at: http://www.cannondale.com/manual_ebikes/

Your Cannondale Dealer

To make sure your bike is serviced and maintained correctly, and that you protect applicable warranties, please coordinate all service and maintenance through your authorized Cannondale Dealer.

NOTICE

Unauthorized service, maintenance, or repair parts can result in serious damage and void your warranty.

Contacting Cannondale

Cycling Sports Group Europe B.V
Mail: Postbus 5100
Visits: Hansepoort 27
7570 GC, OLDENZAAL, Netherlands
Tel: +41 61 4879380
Fax: +31 5415 14240

CONTENTS

CANNONDALE

Safety Information	2
Parts Of The E-Series Bike	4
LEFTY RIGID Front Wheel	5
Maintenance / Cleaning / Torque	7
Geometry / Replacement Parts	8

SHIMANO STEPS E6000 SERIES

This section contains SHIMANO STEPS E6000 drive assist system information (safety information, drive system controls and ebike operation).

See CONTENTS on page	9
----------------------------	---

This supplement contains owner's information for the following bike models:

MODEL CODE	MODEL DESCRIPTION
CM2508 ** 01	KINETTO MEN RIGID
CM2488** 01	KINETTO MEN
CF2489 ** 01	KINETTO WOMENS

** Indicates size(cm) of bike



This bike complies with EN 15194.
EN14764 - Electrically Power Assisted Cycles (EPAC).

SAFETY INFORMATION

Intended Use

Your E-Series bike has an electric pedal assist drive system. It is not a moped or motorcycle. In EU countries, it is known legally as an "EPAC" cycle or Electrically Powered Assisted Cycle.

The drive assist system consists of a drive unit, a battery, a computer control, and various electronic components (harness wires, sensors, and switches). Your E-Series bike does share components common with pedal-only bikes.

It is important to know that when the assist system is turned ON, the drive unit engages to provide power only while you are pedaling. The amount of power provided by the drive unit depends on your pedaling force and the assistance mode/level you set with the handlebar control unit. At anytime, if you stop pedaling, the drive assist will dis-engage. In all modes/levels, the drive assist system power reduces progressively and cuts off as the bike reaches a speed of 25 km/h, (15.5 mph), or sooner if you stop pedaling. The drive-assist re-engages when speed drops below 25 km/h, (15.5 mph) as long as the pedals are turning.

Whenever the drive assist system is turned OFF, you can pedal the bike normally. The drive system will not engage.

KINETTO

ASTM CONDITION 2,
General Purpose
Riding

INTENDED: For paved roads, gravel or dirt roads that are in good condition, and bike paths.

NOT INTENDED: For off-road or mountain bike use, or for any kind of jumping.

Maximum Weight Limit (Lbs/Kg)

RIDER	LUGGAGE	TOTAL
300/136	55/25	330/150

WARNING

****INTENDED USE:** This bicycle is intended to be used as a commuter bicycle. This bike complies with the requirements of European Standard EN 15194, Electrically Power Assisted Cycles. The drive assist system is limited to a maximum continuous power rating of 0.25 kW (250 W) and a maximum speed of 25Km/h, (15.5 mph).

NOT INTENDED: You must not ride this bike in automobile traffic lanes. This vehicle must only be operated on paved surfaces that are legally open to commuter pedal bicycles. This bike is not for mountain biking use, jumping, or racing.

YOU MUST FOLLOW ALL LOCAL LAWS: It is your responsibility to identify and follow all local laws and regulations (including fitting your bike with additional equipment) necessary to comply with local laws. Ask your Cannondale Dealer for more information about operating an electrically assisted pedal bicycle in your area.

DO NOT MODIFY THIS BICYCLE/FORK IN ANY WAY FOR ANY REASON. Doing so can result in severe damage, faulty or dangerous operating conditions, or violation of local laws.

IMPORTANCE OF PRACTICE & RIDER TRAINING - Before you ride this bike, practice riding in a safe area free from hazards. Take time to learn to bike's controls and performance. Practice the controls and gain the experience necessary to avoid the many hazards you will encounter while riding.

DO NOT RIDE "HANDS-OFF" - Keep your hands on and the handlebars when riding the bike. If you remove your hands from the handlebar while riding, you can lose control of the bicycle and crash.

UNDERSTAND YOUR BIKE AND ITS INTENDED USE. USING YOUR BIKE THE WRONG WAY IS DANGEROUS.

Please read your Cannondale Bicycle Owner's Manual for more information about Intended Use and Conditions 1-5.

YOU CAN BE YOU SERIOUSLY INJURED, PARALYZED OR KILLED IF YOU IGNORE THESE WARNINGS.

Read the Drive System Manufacturer's Instructions

WARNING

MANUFACTURER'S INSTRUCTIONS -In addition to this supplement, you must read and follow the manufacturer's instructions for all components of the drive assist system. These instructions contain correct operation, service and maintenance information. More information please visit: http://www.cannondale.com/manual_ebikes/.

LEFTY Rigid Front Wheel

WARNING

- **DO NOT CONTAMINATE BRAKE CALIPER, PADS, OR ROTOR WITH GREASE.**
- **DO NOT RIDE WITHOUT A PROPERLY MOUNTED, ADJUSTED, AND FUNCTIONING FRONT BRAKE SYSTEM.** The Lefty (disc/caliper) acts as an integral secondary wheel retention system. If the system is missing or improperly installed, or if the wheel hub axle bolt should loosen, the front wheel could slide off the spindle end.

When mounting IS compatible brake systems: Follow brake manufacturer's instructions when mounting the brake caliper to the spindle brake bosses. Do not modify the fork in any way. **PLEASE ASK YOUR CANNONDALE DEALER FOR HELP WHEN INSTALLING COMPATIBLE FRONT BRAKE SYSTEMS.**

NOTICE

- **LOCATE BRAKE ROTOR BETWEEN THE PADS.** Replace shims that are in use, be sure the shims are positioned between the caliper (adapter if any) and inner face of the fork mounts, not under the head of the caliper bolts.
- **USE ONLY THE LEFTY 16mm CALIPER BOLTS TO MOUNT THE BRAKE.** Longer bolts can result in contact with the brake rotor causing severe damage. Check clearance between the bolt tips and rotor after remounting the caliper. Order replacement bolts - Cannondale p/n LEFTYBOLTS.

Rear Rack & Kickstand

WARNING

Do not sit on the bicycle with the kickstand down. Kickstand is not designed to support the weight of a person. Make sure kickstand is up before riding.

Do not overload the rear rack. Make sure the cargo is secured properly.

RACK MAXIMUM WEIGHT LIMIT: 25Kg, 55lbs

YOU CAN BE YOU SERIOUSLY INJURED, PARALYZED OR KILLED IF YOU IGNORE THESE WARNINGS.

No Modification

WARNING

DO NOT ALTER, CHANGE, OR MODIFY THE BICYCLE OR THE DRIVE ASSIST SYSTEM. Dealers and owners MUST NOT change, alter, or modify in any way the original components of the bicycle or drive assist system. Specifically attempts to "hot-rod" or "improve" the speed of the bike are dangerous to the rider. Use only specified CANNONDALE and manufacturer drive assist service and replacement parts.

YOU CAN BE YOU SERIOUSLY INJURED, PARALYZED OR KILLED IF YOU IGNORE THESE WARNINGS.

PARTS OF THE E-SERIES

KINETTO RIGID



- 1 Drive Assist Display
- 2 Drive motor
- 3 Drive Control
- 4 Sensor/Spoke magnet
- 6 Battery
- 7 LEFTY Rigid
- 8 LEFTY Wheel Hub
- 9 Bell

KINETTO WOMENS



LEFTY RIGID

Wheel Removal

- See Figure 1. Use a 5 mm Allen key to loosen the brake caliper mounting bolts enough to remove the brake caliper from the mounting tabs.
Note brake alignment shims between brake bosses and the caliper. Replace correctly during reinstallation.
- See Figure 2. Insert a 5 mm Allen key into the axle hub bolt and turn the the hub extraction bolt counter-clockwise.

Continue turning the extraction bolt until the wheel can be removed easily from the spindle end. See Figure 3.



NOTICE

- Make sure the axle bolt is completely disengaged before attempting to remove the wheel. Never try to pull the wheel off forcefully.
- When the wheel is off, to keep dirt out, cover the hub opening.
- Protect spindle from damage when wheel is removed.



Wheel Installation

- Inspect inside the wheel hub for contamination and the condition of the hub seal. Take corrective action if necessary. Wipe the spindle clean with a dry shop towel. Apply a high-quality bike grease to I.D. of the bearings inside the hub.
- Slide the wheel straight onto the spindle.
- Turn the axle bolt clockwise to engage the spindle threads. Make sure the wheel and spindle are supported while tightening the hub bolt.
- Once the hub has been drawn onto the hub completely, use torque wrench to tighten to final 15.0 N•m (133.0 In•Lbs).
- Reinstall the brake caliper. Tighten bolts to 78.0 In•Lbf (9.0 N•m).
- Spin the wheel to make sure it moves freely. Be sure to test the brakes for proper operation before riding.



MAINTENANCE

The following table lists only supplemental maintenance items. Please consult your Cannondale Bicycle Owner's Manual for more information on basic bike maintenance. Consult with your Cannondale Dealer to create a complete maintenance program for your riding style, components, and conditions of use. Follow the maintenance recommendations given by the component manufacturer's for the various non-Cannondale parts of your bike.

CHECK THE FOLLOWING BEFORE EACH RIDE:

- Make sure the battery is fully charged and locked securely in position on the bicycle.
- Check tire pressure and wheel condition. Make sure wheel quick release are firmly closed.
- Check the drive chain condition. Make sure it is clean and well-lubricated.
- Check the bicycle front and rear lighting to make sure it works properly.
- Check the bicycle brakes, make sure they are working well.
- Inspect condition of electrical cables (i.e. Kinks free, no signs of abrasive wear)
- Test the drive assist system, make sure the drive system functions normally.
- **LEFTY RIGID** - Check the fork for signs of damage (bending, cracking, dents, or deep scratches).
- **IF YOU FIND ANY DAMAGE, DO NOT RIDE THE BIKE, CONTACT YOUR CANNONDALE DEALER.**

TO BE PERFORMED BY CANNONDALE DEALER :

Recommended after the first 150 km, bring your bike to your Cannondale Dealer for an initial check-up. It should include checks of the drive assist system, drive chain condition, proper shifting, accessories, wheels and tire condition, brakes, etc. This visit will help you establish a schedule for repeated visits appropriate for how and where you ride.

Every 1000 km, bring your bike in to your Cannondale Dealer for a regular detailed inspection, adjustment, and replacement of wear items across the entire bike. Electrically powered assist cycle (electric bikes) can wear out wheels, tires, drive chain, brakes, more quickly.



ANY PART OF A POORLY MAINTAINED BIKE CAN BREAK OR MALFUNCTION LEADING TO AN ACCIDENT WHERE YOU CAN BE KILLED, SEVERELY INJURED OR PARALYZED. Please ask your Cannondale Dealer to help you develop a complete maintenance program, a program which includes a list of the parts on your bike for YOU to check regularly. Frequent checks are necessary to identify the problems that can lead to an accident.

Cleaning

When cleaning your bike, use a damp sponge or a soft brush with only a mild soap and water solution. Rinse the sponge often. Do not spray water.

NOTICE

Do not use a pressure washer or dry with compressed air. This will force contaminants into sealed areas, electrical connections/components promoting corrosion, immediately damaging, or result in accelerated wear.



WARNING

KEEP WATER AWAY FROM THE ELECTRICAL COMPONENTS.

MAKE SURE THE BIKE IS SECURED UPRIGHT AND CAN NOT FALL OVER ACCIDENTALLY WHILE YOU ARE CLEANING IT. Don't rely on the kickstand. Use a sturdy portable bicycle wheel stand to hold the bike upright.

Tightening Torques

Correct tightening torque for the fasteners (bolts, screws, nuts) on your bicycle is very important to your safety, the durability and performance of your bicycle. We urge you to have your Dealer correctly torque all fasteners using a torque wrench.

DESCRIPTION	Nm	In Lbs	Loctite™
Kickstand	7.0	62.0	
Rear Rack Mounting Bolts	3 - 4	26.5 - 35.4	
Stem/Handlebar Clamp Bolts	6.0	53.0	242 (blue)
Rear Derailleur Hangar Screws	2.5	22.0	
Lefty Clamp Bolts	7-9	62-80	
Lefty Wheel Axle Bolt	15	133	

If you decide to tighten fasteners yourself always use a good torque wrench!

Drive Unit

NOTICE

Drive unit is maintenance-free and must only be serviced at an authorized service center. This will ensure the quality and safety of the driving unit. Never attempt to open, remove it from the frame, or work on it yourself. Other components of the eBike drive (e.g. drive chain, front chain ring, rear cassette, rear derailleur, crankarm) must be serviced by your Cannondale Dealer. Replacement parts must be identical to the original Cannondale specification for the bike. See **Specifications**. Failure to replace components with original specification can result in serious overload or other damage to the drive unit. Unauthorized opening or service of the drive unit will void the warranty. The drive system will not function without the computer unit attached to the base properly. If the computer disconnects from the base during operation, the drive system will shut off. If this happens you will have to stop the bike, turn the system off, re-attach the computer to the base, and then turn the system back on to resume. Remove the computer when not operating the bike to prevent theft or unauthorized use.

GEOMETRY

- A - Seat Tube Length
- B - Top Tube Horizontal
- D - Head Tube Angle
- E - Seat Tube Angle
- G - Head Tube Length
- H - Wheelbase
- I - Front Center
- J - Chain Stay Length
- K - Bottom Bracket Drop
- L - Bottom Bracket Height
- M - Fork Rake
- O - Stack
- P - Reach
- Z - Crown Height

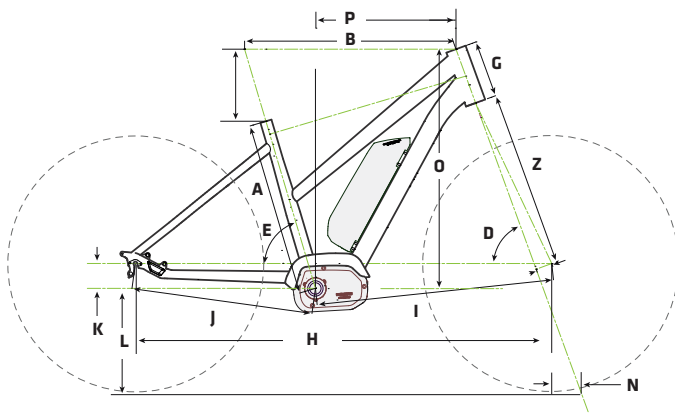

MODEL	Size (cm)	Size														
		A	B	D	E	G	H	I	J	K	L	M	N	O	P	Z
KINNETTO (Men's)	M	44.0	55.0	69.0°	74.0°	15.4	112.0	63.8	49.0	6.7	28.6	4.5	8.7	64.0	36.6	47.7
	L	52.0	58.5	70.0°	73.0°	15.4	113.1	65.0	49.0	6.7	28.6	4.5	8.0	64.5	38.8	47.7
	XL	60.0	62.0	71.5°	72.5°	15.4	114.3	66.1	49.0	6.7	28.5	4.5	7.0	65.1	41.5	47.7
KINNETTO (Women's)	XS	42.0	55.0	69.0°	75.0°	47.7	113.2	65.0	49.0	6.7	28.6	4.5	8.7	64.0	37.8	47.7
	S	47.0	57.0	70.0°	73.5°	47.7	112.3	64.1	49.0	6.7	28.6	4.5	8.0	64.5	37.9	47.7
	M	53.0	57.8	70.0°	73.0°	47.7	112.5	64.3	49.0	6.7	28.6	4.5	8.0	64.5	38.1	47.7

KEYS

Your E-Series bike comes with a main key and spare key. The keys are identified by the serial number **SERIAL**. Please record the key serial number for future use and key replacement. If your keys are ever lost or stolen, or you would like additional spares, please contact:

Replacement information by key manufacturer:

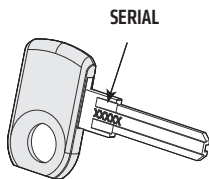

AXA

<http://www.axa-stenman.com>



www.abus.com



<http://www.trelock.de/web/en/services/schluesselservice/schluesselservice.php>

NOTICE

Don't ride with key in battery lock. Always remove the key from the lock after using it. Keys may be stolen or break off accidentally in the lock. Keep your spare key in a safe place.

Record SERIAL here.

CONTENTS

IMPORTANT NOTICE	10
Important safety information	10
To ensure safety.....	10
Features of SHIMANO STePS.....	13
Features.....	13
Riding the bicycle.....	13
Assist mode.....	13
Names of parts.....	14
Specifications.....	15
Method of use	16
Charging the battery.....	16
Battery level indicator	17
Handling and charging the battery	17
Installing / removing the battery.....	18
Turning the power ON / OFF	20
Switching modes	21
Installing and removing the cycle computer	21
Changing settings	22
Operating the cycle computer.....	22
SHIMANO STePS logo screen.....	22
Basic screen display	23
Launching and exiting the setting menu	28
Changing the settings.....	29
Connection and communication with the PC.....	33
Downloading application	33
Troubleshooting	34
Battery level and error indication	34
Error messages on the cycle computer	35
Troubleshooting.....	39



User's manuals in other languages are available at :
<http://si.shimano.com>

IMPORTANT NOTICE

- Contact the place of purchase or a bicycle dealer for information on installation and adjustment of the products which are not found in the user's manual. A dealer's manual for professional and experienced bicycle mechanics is available on our website (<http://si.shimano.com>).
- Do not disassemble or alter this product.
- Use the product according to local laws and regulations.

For safety, be sure to read this user's manual thoroughly before use, and follow them for correct use.

Important safety information

Guidelines that require replacement, contact the place of purchase or a bicycle dealer.

Be sure to observe the following in order to avoid burns or other injury from fluid leakages, overheating, fire or explosions.

To ensure safety



Handling the battery

- Do not deform, modify, disassemble or apply solder directly to the battery. Doing so may cause leakage, overheating, bursting, or ignition of the battery.
- Do not leave the battery near sources of heat such as heaters. Do not heat the battery or throw it into a fire. Doing so may cause bursting or ignition of the battery.
- Do not subject the battery to strong shocks or throw it. If this is not observed, overheating, bursting, or fire may occur.
- Do not place the battery into fresh water or sea water, and do not allow the battery terminals to get wet. Doing so may cause overheating, bursting, or ignition of the battery.
- Use the battery and charger combination specified by the company for charging and follow the charging conditions specified by the company. Not doing so may cause overheating, bursting, or ignition of the battery.



To ensure safe riding

- Do not give too much of your attention to the cycle computer display while riding, otherwise accidents may result.
- Check that the wheels are securely installed to the bicycle before commencing riding. If the wheels are not securely installed, the bicycle may fall over and serious injury may result.
- If riding a power-assisted bicycle, make sure that you are fully familiar with the starting-off characteristics of the bicycle before riding it on roads with several vehicle lanes and pedestrian footpaths. If the bicycle starts off suddenly, accidents may result.
- Check that the bicycle lights illuminate before riding at night.

Using the product safely

- Always be sure to remove the battery before carrying out any wiring and assembly work for the bicycle, otherwise electric shocks may result.
- When installing this product, be sure to follow the instructions given in the user's manual. Furthermore, it is recommended that you use only genuine Shimano parts at these times. If bolts and nuts are left loosened or the product is damaged, the bicycle may suddenly fall over and serious injury may result.
- After reading the user's manual carefully, keep it in a safe place for later reference.

Handling the battery

- If any liquid leaking from the battery gets into your eyes, immediately wash the affected area thoroughly with clean water such as tap water without rubbing your eyes, and seek medical advice immediately. If this is not done, the battery liquid may damage your eyes.
- Do not recharge the battery in places with high humidity or outdoors. Doing so may result in electric shock.
- Do not insert or remove the plug while it is wet. If this is not observed, electric shocks may result. If there is water leaking out of the plug, dry it thoroughly before inserting it.
- If the battery does not become fully charged after 6 hours of charging, immediately unplug the battery from the outlet to stop charging, and contact the place of purchase. Doing so may cause overheating, bursting, or ignition of the battery.
- Do not use the battery if it has any noticeable scratches or other external damage. Doing so may cause bursting, overheating or problems with operation.
- The operating temperature ranges for the battery are given below. Do not use the battery in temperatures outside these ranges. If the battery is used or stored in temperatures outside these ranges, fire, injury or problems with operation may occur.
 1. During discharge: $-10\text{ }^{\circ}\text{C}$ - $50\text{ }^{\circ}\text{C}$
 2. During charging: $0\text{ }^{\circ}\text{C}$ - $40\text{ }^{\circ}\text{C}$

Cleaning

- The frequency of maintenance will vary depending on the riding conditions. Periodically clean the chain using an appropriate chain cleaner. Do not use alkaline or acidic cleaning agents for removing rust under any circumstances. If such cleaning agents are used, they may damage the chain and serious injury may result.



To ensure safe riding

- Observe the instructions in the user's manual for the bicycle, in order to ride safely.

Using the product safely

- Examine the battery charger regularly for damage, especially the cord, plug and enclosure. If the battery charger is damaged, it must not be used until it has been repaired.
- This appliance is not intended for use by persons (including children) with reduced physical, sensory or mental capabilities, or lack of experience and knowledge, unless they have been given supervision or instruction concerning use of the appliance by a person responsible for their safety.
- Do not allow children to play near the product.

Handling the battery

- Do not leave the battery in a place exposed to direct sunlight, inside a vehicle on a hot day, or other hot places. This may result in battery leakage.
- If any leaked fluid gets on your skin or clothes, wash it off immediately with clean water. The leaked fluid may damage your skin.
- Store the battery in a safe place out of the reach of infants and pets.

Cleaning

- If any malfunctions or other problems occur, contact the place of purchase.
- Never attempt to modify the system yourself, as it may cause problems with system operation.

Note

Using the product safely

- Be sure to install caps to any connectors which are not being used.
- For installation and adjustment of the product, consult a dealer.
- The Product is designed to be fully waterproof to withstand wet weather riding conditions. However, do not deliberately place them into water.
- Do not clean the bicycle in a high-pressure wash. If water gets into any of the components, operating problems or rusting may result.
- Handle the product carefully, and avoid subjecting it to any strong shocks.
- Although the bicycle still functions as a normal bicycle even when the battery is removed, the light does not turn on if it is connected to the electric power system. Be aware that using the bicycle under these conditions will be considered non-observance of the road traffic laws in Germany.

Handling the battery

- When you carry a power-assisted bicycle in a car, remove the battery from the bicycle and place the bicycle on a stable surface in the car.
- When attaching the battery, check that no water has accumulated on the connector to the battery, then connect it.

Disposal information for countries outside the European Union



This symbol is only valid within the European Union. Follow local regulations when disposing of used batteries. If you are not sure, consult the place of purchase or a bicycle dealer.

Label

- Some of the important information contained in this user's manual is also indicated on the battery charger label.

Cleaning

- The number found on the battery key is necessary when purchasing spare keys. Keep it in a safe place.
- Contact the place of purchase for updates of the product software. The most up-to-date information is available on the Shimano website. For details, refer to the "Connection and communication with the PC" section.
- Do not use thinner or other solvents to clean any of the products. As such substances may damage the surfaces.
- You should periodically wash the chainrings in a neutral detergent. In addition, cleaning the chain with neutral detergent and lubricating it can be an effective way of extending the useful life of the chainrings and the chain.
- Use a damp cloth, with the water well wrung out, when cleaning the battery and plastic cover.
- For any questions regarding handling and maintenance, contact the place of purchase.
- Products are not guaranteed against natural wear and deterioration from normal use and aging.
- For maximum performance we highly recommend Shimano lubricants and maintenance products.

Assist

- If the settings are not correct, for instance if the chain tension is too tight, the proper assist force may not be obtained. If this happens, contact the place of purchase.
- Do not disassemble the product. Disassembling it may cause injury to persons.

Features of SHIMANO STePS

■ Features

- **Lightweight, compact design**
- **Silent, smooth ride**
- **High shifting performance system (In the case of electronic gear shifting)**

This system enables you to shift gears by providing the most appropriate level of power assistance carefully adjusted by a computer control based on accurate sensing.

- **Walk assistance function**
- **Start mode (In the case of electronic gear shifting)**



This function allows automatic shifting down to a preset gear when you stop the bicycle such as at traffic lights so that you can start traveling at a light gear.

■ Riding the bicycle

1. Turn on the power.
2. Select your preferred assist mode.
3. Assistance will start when the pedals start turning.
4. Change the assist mode in accordance with the riding conditions.
5. Turn the power off when parking the bicycle.

■ Assist mode

You can select a SHIMANO STePS assist mode for each particular application.

HIGH	NORMAL	ECO
		
Use when powerful assistance is required, such as when riding up steep uphill slopes.	Use when an intermediate level of assistance is needed, such as when you want to enjoy riding comfortably on a gentle slope or level ground.	Use when you want to enjoy long distance riding on level ground. When pedaling is not very strong, the amount of assistance is reduced and energy consumption is lessened.
When the battery level is running low, the level of assistance is lowered to increase the traveling range.		
OFF		
This mode does not provide power assistance when the power is turned on. Since there is no power consumption associated with the power assistance, it is useful for reducing battery consumption when the battery is running low.		
WALK		
This mode is particularly useful when you walk the bicycle with heavy baggage on it or walk it out of a basement.		

Names of parts

<BT-E6000 / SM-BME60>

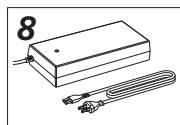
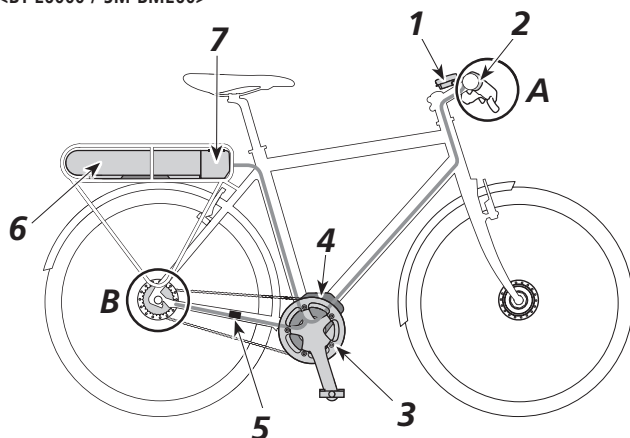

< In the case of electronic gear shifting >

A	Shifting switch	SW-E6000
B	Motor unit	MU-S705
	Internal geared hub	SG-C6060
		SG-S705
	SG-S505	

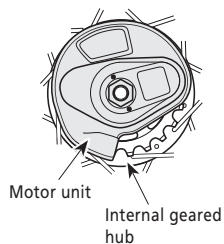

<BT-E6010 / SM-BME61>

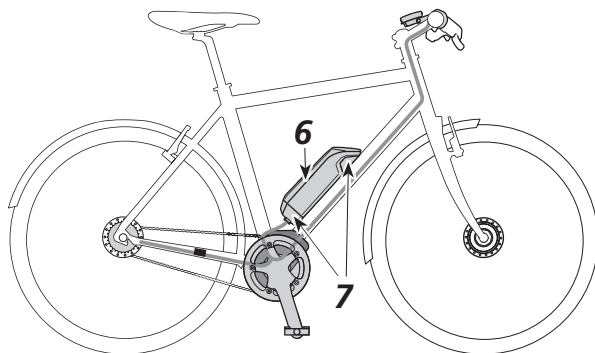

1	Cycle computer	SC-E6000	5	Speed sensor	
2	Assist switch	SW-E6000	6	Battery	BT-E6000 / BT-E6010
3	Front gear / Crank arm	FC-E6000 / SM-CRE60	7	Battery mount	SM-BME60 / SM-BME61
4	Drive unit	DU-E6000 / DU-E6001	8	Battery charger	SM-BCE60

Specifications

Operating temperature range: During discharge	-10 – 50°C	Nominal capacity	11.6 Ah
Operating temperature range: During charging	0 – 40°C	Rated voltage	36 V DC
Storage temperature	-20 – 70°C	Drive unit type	Midship
Storage temperature (Battery)	-20 – 60°C	Motor type	Brush-less DC
Charging voltage	100 – 240 V AC	Rated drive unit power	250 W
Charging time	About 4 hours	Maximum drive unit power	500 W
Battery type	Lithium ion battery		

Method of use

■ Charging the battery

1. Attach the charger plug to the charger connector of the battery.

Insert it with the groove side of the connector facing up.

* You cannot insert it with the groove side facing down.

⚠ DANGER

- Use the battery and charger combination specified by the company for charging and follow the charging conditions specified by the company. Not doing so may cause overheating, bursting, or ignition of the battery.



- You cannot use the battery immediately after purchase. Before riding, be sure to charge the battery until it is fully charged.
- If the bicycle is stored for an extended period of time immediately after purchase, you will need to charge the battery before using the bicycle. Once the battery is charged, it starts to deteriorate.

2. After charging has started, the LED lamp on the charger lights up.





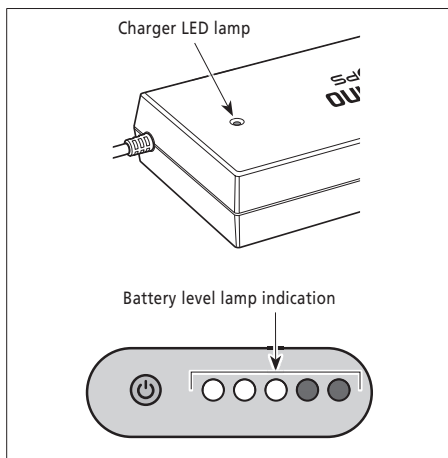
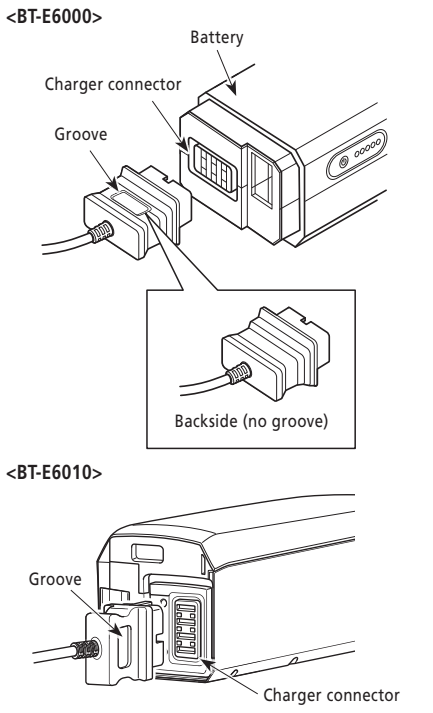

You can check the current charging status on the battery level lamp located on the battery.

○ Lights up	Charging (Within 1 hour after the completion of charging)
⚡ Flashing	Charging error
● Turned off	Battery disconnected (1 hour or more after the completion of charging)









■ Battery level indicator

Charging-in-progress indication

Battery level indicator*1	Battery level
	0% - 20%
	21% - 40%
	41% - 60%
	61% - 80%
	81% - 99%
	100%

*1 ● : No light ○ : Lights up  : Flashing

Battery level indication

Battery level indicator*1	Battery level
	100% - 81%
	80% - 61%
	60% - 41%
	40% - 21%
	20% - 1%
	0%
	Power off / Shutdown

*1 ● : No light ○ : Lights up  : Flashing

■ Handling and charging the battery

Charging can be carried out at any time regardless of the amount of charge remaining, but you should fully charge the battery at the following times. Be sure to use the special charger when recharging the battery at these times.

- The battery is not fully charged at the time of purchase. Before riding, be sure to charge the battery until it is fully charged.
- If you will not use the bicycle for an extended period of time, charge the battery before storing the bicycle.

If the battery has become fully spent, charge it as soon as possible. If you leave the battery without charging it, it will cause the battery to deteriorate.

- If you will not ride the bicycle for an extended period of time, charge the battery periodically. Do not let the battery discharge completely.

■ Installing / removing the battery

How to use the key

The following description may not be applicable as different types of keys are available.

1. Insert the key into the key cylinder in the battery holder.



- The position of the key does not affect the insertion of the battery. You can insert it regardless of the key position.
- You cannot remove the key when it is not in the inserting position.

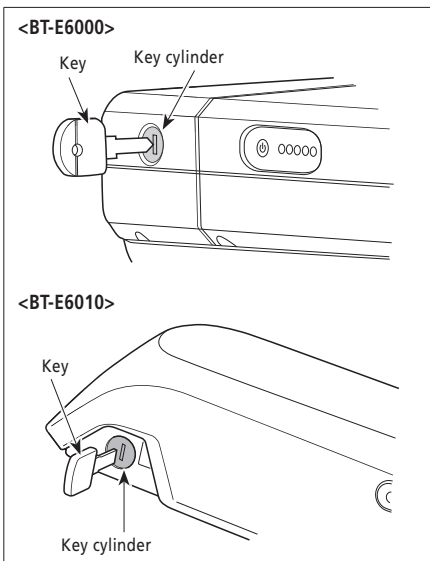

2. To unlock the battery turn the key until you feel some resistance.

CAUTION

To prevent the battery from dropping off, do not ride the bicycle with the key inserted.

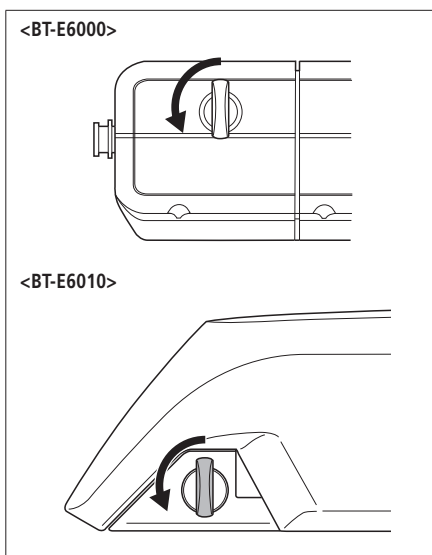

Removing the battery

<BT-E6000>

Turn off the power, then turn the key to the unlocking position, and pull out the battery.



You can remove the battery only when the key is in the unlocking position.

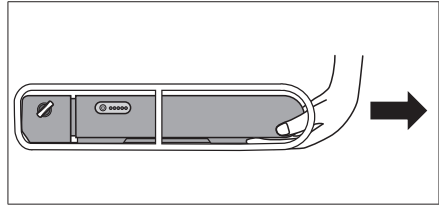

<BT-E6010>

Turn off the battery then turn the key to the unlocking position. Hold the upper part of the battery and slide it to the left to remove it.

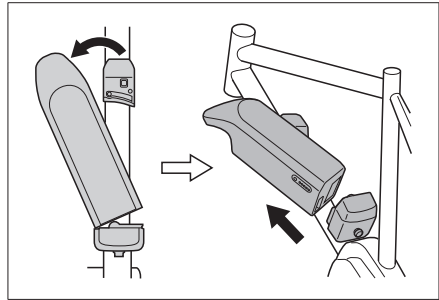

Installation of the battery

<BT-E6000>

1. Set the battery on the holder rail from behind and slide it forward. Push it in firmly.
2. Return the key to the locking position, remove it, and store it in a safe place.

CAUTION

Check that the battery is locked before riding the bicycle.

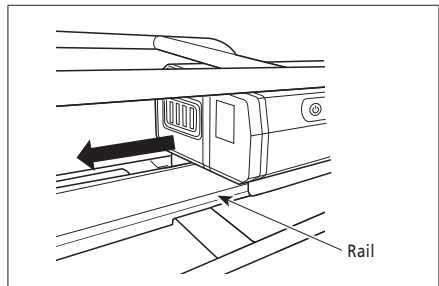

<BT-E6010>

1. Align the indentation in the bottom of the battery with the protrusion on the holder and insert the battery.

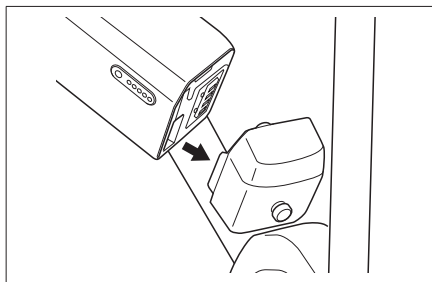

2. Slide the battery to the right starting from the point where it is inserted. Push in the battery until you hear it click.

3. Return the key to the locking position, remove it, and store it in a safe place.

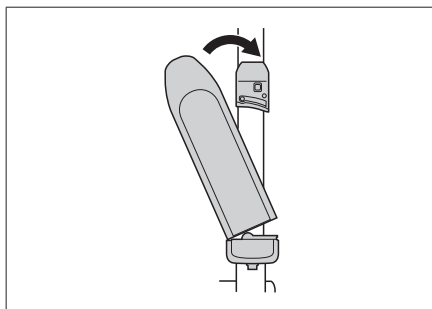

CAUTION

Check to see that the battery is locked before riding the bicycle.

■ Turning the power ON / OFF

Press the power button once with the power turned ON or OFF. All the indicators turn on when the power is on.

CAUTION

When turning on the power, check that the battery is firmly attached to the holder.



When turning the power ON or OFF, do not place your foot on the pedal.

Automatic power off function

If the bicycle has not moved for over 10 minutes, the power will automatically turn off.

<BT-E6000>

Power button

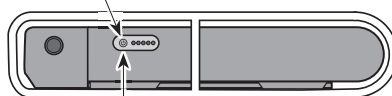

Press once

<BT-E6010>

Power button



Press once

■ Switching modes

X	Changing the cycle computer display
Y	When switching assist modes: the level of assistance becomes stronger
	When shifting gears: pedaling becomes heavier
Z	When switching assist modes: the level of assistance becomes weaker
	When shifting gears: pedaling becomes lighter

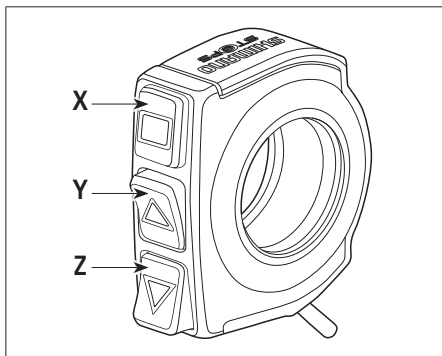

■ Installing and removing the cycle computer

Slide the cycle computer onto the bracket as shown in the illustration to install it.

Insert the cycle computer securely until it clicks into place.

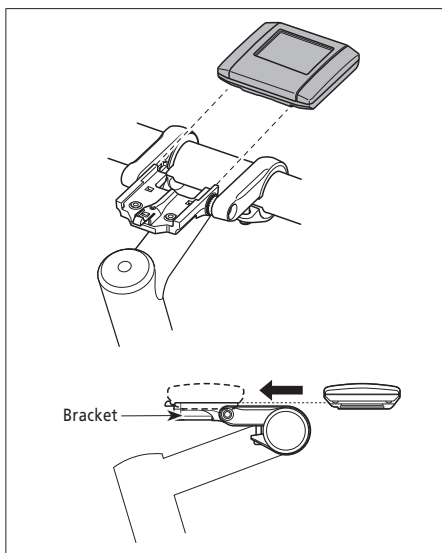

To remove the cycle computer, push the lever of the bracket firmly while sliding out the cycle computer.

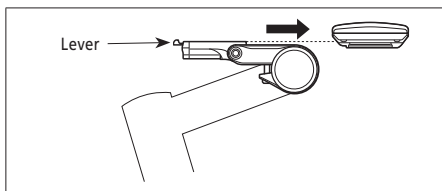

If the cycle computer is not correctly in place, the assist function will not operate normally.

Changing settings

■ Operating the cycle computer

You can operate the display of the cycle computer by using the X, Y, and Z buttons on the right and left assist switches.

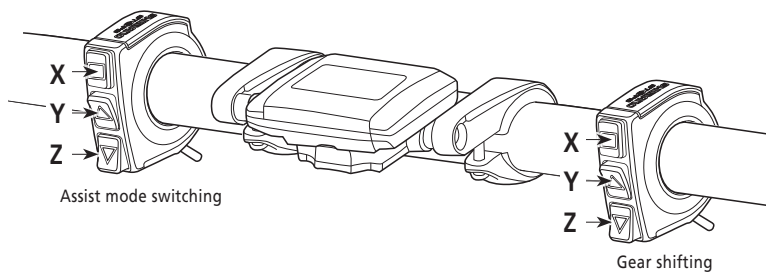
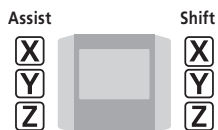

The operation procedure provided here refers to cases where the cycle computer is set to the default values.

■ SHIMANO STePS logo screen

This screen is displayed when the system is started up.



Basic screen display

Displays the status of the power assisted bicycle, traveling data.



1. Current speed

Displays the current speed.

2. Current time

Shows the current time.

3. Battery charge

Displays the current battery level in six levels.

* The battery level is not displayed when the traveling data in **6** shows "RANGE".

4. Speed unit display

You can switch between km/h and mph.

* Battery level indicator

You can check the battery level on the cycle computer while riding.

Display	Battery level
	81 - 100%
	61 - 80%
	41 - 60%
	21 - 40%
	1 - 20%
	0%



5. Changing the assist mode display

Press Assist-Y or Assist-Z on the assist switch to switch assist modes.

Display	Details
◀ HIGH ▶	Assist high
◀ NORM ▶	Assist normal
◀ ECO ▶	Assist eco
◀ OFF ▶	Assist off
◀ WALK ▶	Walk assist

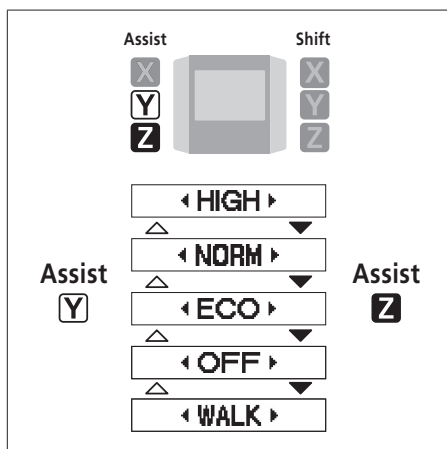

<Walk assist mode>

When the speed indicator is "0", pressing the Assist-Z button for 2 seconds switches to the walk assist mode. Press Assist-Y to switch the mode to "OFF".

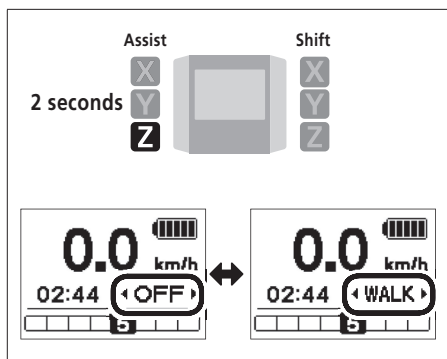

When "WALK" is displayed, press and hold down Assist-Z on the assist switch to start the walk assist function. Releasing Assist-Z stops the walk assist function, or pressing Assist-Y can stop the walk assist function.

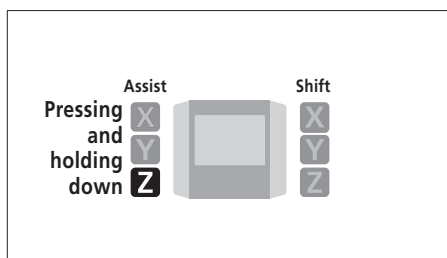

If Assist-Z is not operated for over 1 minute, the mode will change to OFF.



-
- If the bicycle does not move after the walk assist function turns on, the function automatically stops. To restart the walk assist function, release the assist switch and press and hold down Assist-Z again.
 - The walk assist function can operate at a maximum of 6 km/h.
 - The assistance level and speed vary with the gear position.
-



6. Gear position and traveling data display

Displays the current gear ratio or traveling data.

The type of traveling data displayed changes each time you tap Assist-X.

Display	Details								
	Gear position (displayed only when the motor unit is connected)								
	Gear position*4 (when setting start mode)								
◀ DST 109.7 km ▶	Traveling distance								
◀ ODO 11097 km ▶	Cumulative distance								
◀ RANGE 107 km ▶	Traveling range*1 *3								
<table border="1"> <thead> <tr> <th colspan="2">RANGE</th> </tr> </thead> <tbody> <tr> <td>HIGH</td> <td>61 km</td> </tr> <tr> <td>NORM</td> <td>77 km</td> </tr> <tr> <td>ECO</td> <td>97 km</td> </tr> </tbody> </table>	RANGE		HIGH	61 km	NORM	77 km	ECO	97 km	Traveling range (optional)*2
RANGE									
HIGH	61 km								
NORM	77 km								
ECO	97 km								
◀ TIME 143:29 ▶	Traveling time (optional)*2								
◀ AVG 16.8 km/h ▶	Average speed (optional)*2								
◀ MAX 16.8 km/h ▶	Maximum speed (optional)*2								

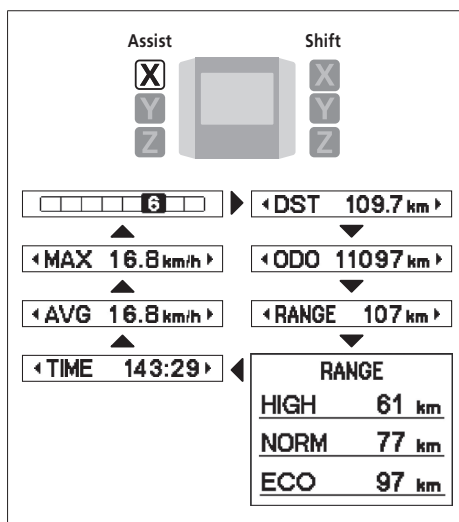

*1 When "RANGE" is displayed, the battery level (shown in 3) and the walk assist indicator (shown in 5) do not appear on the screen.

*2 Optional item: You can configure the display settings in E-tube Project. For details, refer to the "Connection and communication with the PC" section.

*3 When the walk assist function is working, "-" is displayed in the "RANGE" screen.

*4 The starting gear position is displayed when using start mode.

Turning the battery-powered light ON or OFF

When the battery-powered light is connected, pressing the Assist-X for 2 seconds displays this information instead of the clock and assist mode. The light turns on and off each time it is displayed. It is displayed for about 2 seconds.



The light turns on and off in conjunction with the battery power.

When the battery power is off, the light is off.

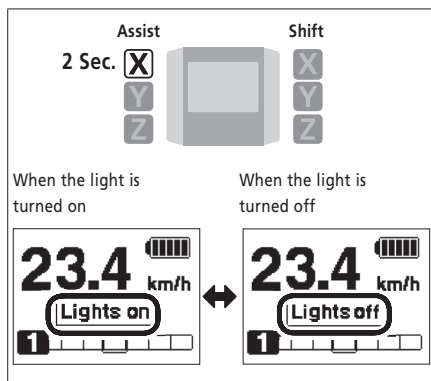

Clearing the traveling distance

When the light is not connected, you can clear the traveling distance in the main screen. If the battery-powered light is connected and configured, clear the traveling distance (DST) according to "Clear settings (Clear)" in "Changing the settings".

1. Change the traveling data display to DST and press the Assist-X for 2 seconds.

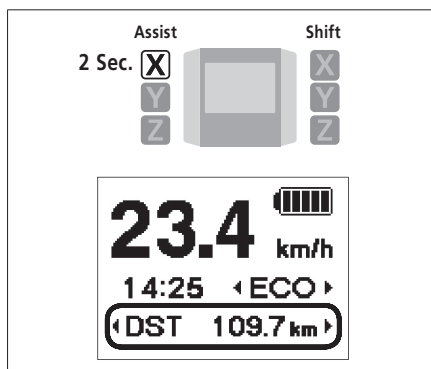

2. Release the finger when the DST indication starts blinking.

In this state, pressing the Assist-X again clears the traveling distance.



- The DST indicator light stops blinking and the screen takes you back to the basic screen after leaving it alone for 5 seconds.
- When the traveling distance is cleared, TIME, AVG, and MAX are also cleared.



■ Launching and exiting the setting menu

Launching

1. With the bicycle stopped, pressing both the Assist-Y and Assist-Z at the same time for 2 seconds displays the setting screen.

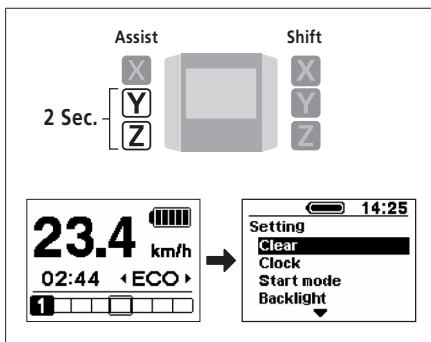

2. Press the Assist-Y or Assist-Z to move the cursor to the item you want to configure. Pressing the Assist-X displays the setting screen for the item selected.

Item	Details
Clear	Clear settings
Clock	Clock setting
Start mode	Start mode setting
Backlight	Backlight setting
Beep	Beep setting
Unit	Switching between km and miles
Language	Language setting
Exit	Return to the main screen

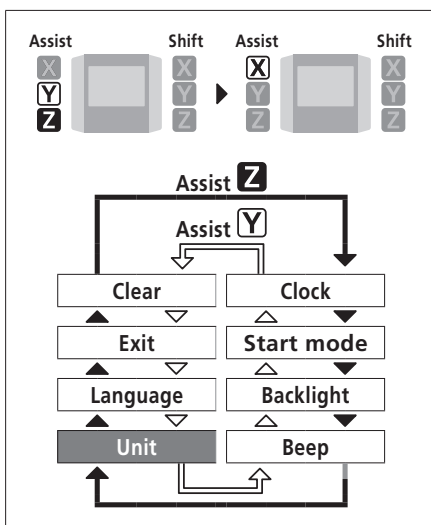

Exit setting (Exit)

1. Press the Assist-Y or Assist-Z to move the cursor to "Exit".
2. Pressing the Assist-X exits the setting menu and takes you back to the basic screen.

■ Changing the settings

Language setting (Language)

Configure the language setting.

1. Press the Assist-Y or Assist-Z to move the cursor to the item you want to configure.

Item
English
Français
Deutsch
Nederlands
Italiano
Español



2. Pressing the Assist-X enables the set value at the cursor position and takes you back to the "Setting menu" screen.

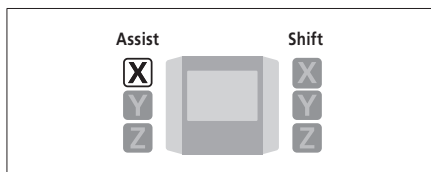

Switching between km and miles (Unit)

Configure the distance unit setting.

1. Press the Assist-Y or Assist-Z to move the cursor to the item you want to configure.

Item	Details
km	Displayed in km
mile	Displayed in miles

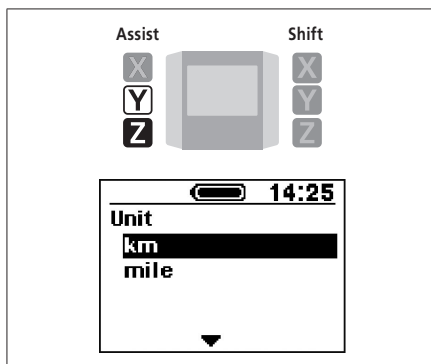

2. Pressing the Assist-X enables the set value at the cursor position and takes you back to the "Setting menu" screen.

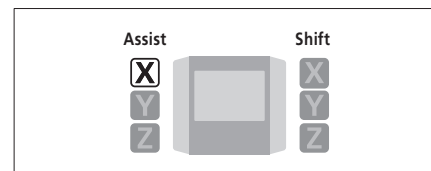

Beep setting (Beep)

Configure the beep setting.

1. Press the Assist-Y or Assist-Z to move the cursor to the item you want to configure.

Item	Details
ON	Enable beeps by operation
OFF	Disable beeps by operation

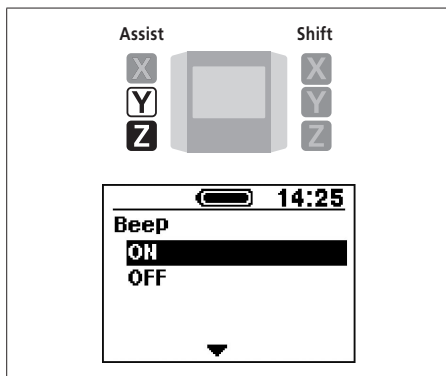

2. Pressing the Assist-X enables the set value at the cursor position and takes you back to the "Setting menu" screen.

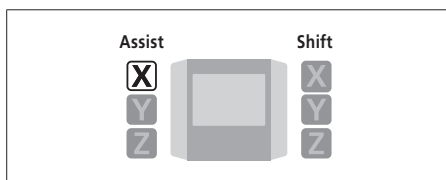

Backlight setting (Backlight)

Configure the backlight setting.

1. Press the Assist-Y or Assist-Z to move the cursor to the item you want to configure.

Item	Details
ON	Always turned on
OFF	Always turned off
MANUAL	Turns on and off in conjunction with the battery-powered light

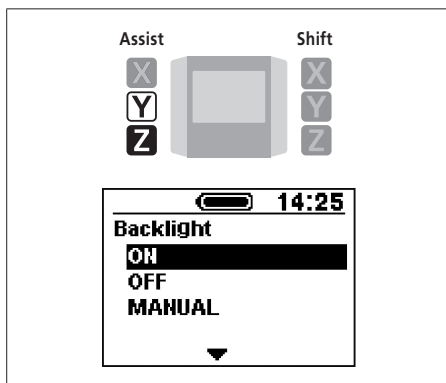

2. Pressing the Assist-X enables the set value at the cursor position and takes you back to the "Setting menu" screen.

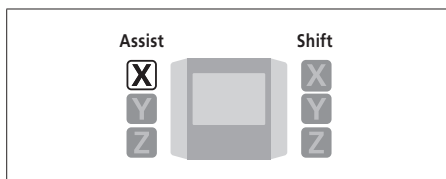

Start mode setting (Start mode)

Sets the start gear when using start mode function.

1. Press the Assist-Y or Assist-Z to move the cursor to the item you want to configure.

Item	Details
OFF	No setting
2	2-speed
3	3-speed
4	4-speed
5	5-speed

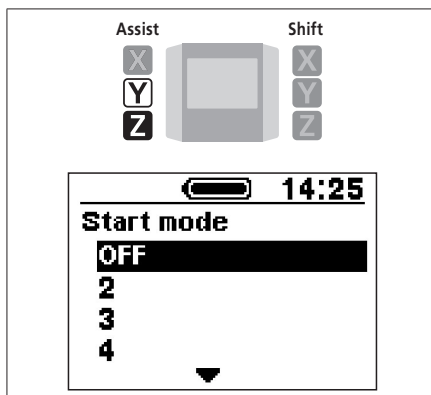

2. Pressing the Assist-X enables the set value at the cursor position and takes you back to the "Setting menu" screen.

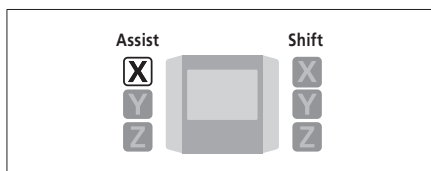

Clock setting (Clock)

Configure the clock setting.

1. Press the Assist-Y or Assist-Z to set the hour.



Press Assist-Y to increase the time value.
Press Assist-Z to decrease the time value.

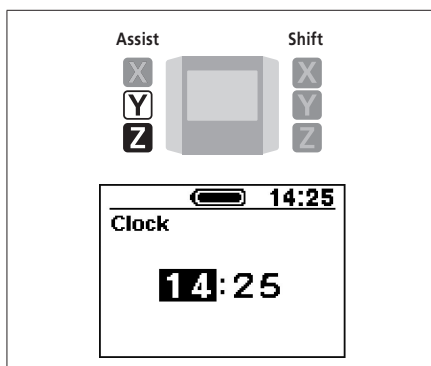

2. Pressing the Assist-X enables the set value and moves you to the minutes setting.

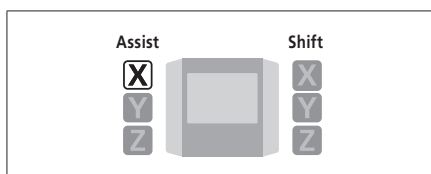

3. Press the Assist-Y or Assist-Z to set the minutes.

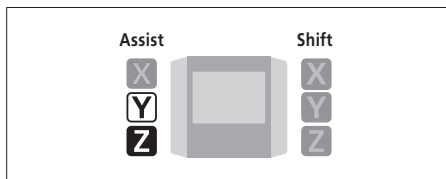

4. Pressing the Assist-X enables the set value and takes you back to the "Setting menu" screen.



You can change the numbers quickly by holding down the Assist-Y or Assist-Z.

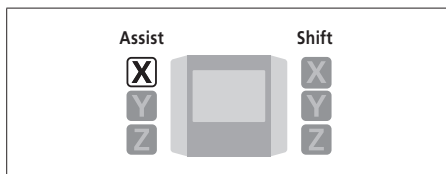

Clear settings (Clear)

Clear the traveling distance, or reset the display setting to default.

1. Press the Assist-Y or Assist-Z to move the cursor to the item you want to configure.

Item	Details
Exit	Return to the setting menu screen
DST	Clearing the traveling distance
Default	Reset the SC display setting to default

Default value set in the SC display setting

Item	Default value
Backlight	ON
Beep	ON
Unit	km
Language	English

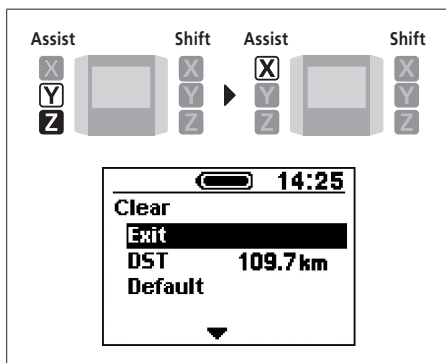

2. Pressing the Assist-X enables the set value at the cursor position and takes you back to the "Setting menu" screen.



When the traveling distance is cleared, TIME, AVG, and MAX are also cleared.

Connection and communication with the PC

■ Downloading application

You need E-tube Project to configure SHIMANO STePS and update firmware.







Download an E-tube Project from the support website (<http://e-tubeproject.shimano.com>). For information on how to install an E-tube Project, check the support website. For information on how to operate the PC, refer to the help manual on the E-tube Project.



-
- You need SM-PCE1 and SM-JC40 / JC41 to connect SHIMANO STePS to a PC.
 - Firmware is subject to change without notice.
- If necessary, contact the place of purchase.
-

Troubleshooting

■ Battery level and error indication

Error indication type	Indication condition	Lighting pattern *1	Recovery
System error	Communication error with the bicycle system	 ● ● ● ○	Make sure that the cable is not loose or improperly connected. If the situation does not improve, contact the place of purchase.
Temperature protection	If the temperature exceeds the guaranteed operating range, the battery output is turned off.	 ● ● ○ ●	Leave the battery in a cool place away from direct sunlight until the internal temperature of the battery decreases sufficiently. If the situation does not improve, contact the place of purchase.
Security authentication error	This is displayed if a genuine drive unit is not connected. This is displayed if any of the cables are disconnected.	 ○ ● ● ●	Connect a genuine battery and drive unit. Check the condition of the cables. If the situation does not improve, contact the place of purchase.
Charging error	This is displayed if an error occurs during charging.	 ○ ● ● ●	Remove the charger from the battery and press the power switch, if an error appears contact an agency.
Battery malfunction	Electrical failure inside the battery	 ● ● ● 	Connect the charger to the battery and then remove the charger. Press the power switch with only the battery connected. If an error appears with only the battery connected, contact the place of purchase.

*1 ● : No light ○ : Lights up  : Flashing

■ Error messages on the cycle computer

WARNING

This disappears if the error is fixed.

A message appears instead of the clock indication.

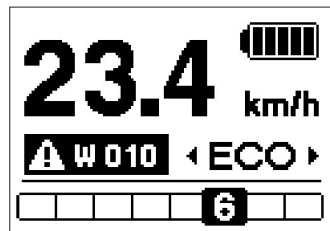

List of warnings

Code	Situation where the error occurred	Condition for removing the operational restriction when a warning is being displayed	Remedy
W010	The temperature of the drive unit is high.	The level of assistance may decrease.	Stop using the assist function until the temperature of the drive unit drops. If the situation does not improve, contact the place of purchase.
W011	The traveling speed cannot be detected.	The maximum speed up to which power assistance is provided may decrease. (Power assistance is provided up to 25 km/h in top gear.)	Check that the speed sensor is properly installed. If the situation does not improve, contact the place of purchase.
W030	Two or more assist switches are connected to the system.	Gear shifting is not available for power gear shifting derailleurs.	Change the assist switch to the gear shifting switch, or connect only one assist switch and turn on the power again. If the situation does not improve, contact the place of purchase.
-	A communication error between the drive unit and the motor unit was detected.	Gear shifting is not available for power gear shifting derailleurs.	Check that the cable is properly connected between the drive unit and the motor unit. If the situation does not improve, contact the place of purchase.

Error

If an error message is displayed on the entire screen, follow one of the procedures below to reset the display.

- Press the power switch of the battery.
- Remove the battery from the holder.



If resetting the battery power does not solve the problem or the same problem occurs frequently, contact the place of purchase.



List of errors

Code	Situation where the error occurred	Operational restriction when an error is being displayed	Remedy
E010	A system error was detected.	Power assistance is not provided during riding.	Press the power switch of the battery to turn it on again. If the situation does not improve, contact the place of purchase.
E012	The initialization of the torque sensor failed.	Power assistance is not provided during riding.	With your foot off the pedal, press the battery power switch and turn on the power again. If the situation does not improve, contact the place of purchase.
E020	A communication error between the battery and drive unit was detected.	Power assistance is not provided during riding.	Check that the cable between the drive unit and battery is properly connected. If the situation does not improve, contact the place of purchase.
E030	A setting error was detected.	Power assistance is not provided during riding.	If the situation does not improve even after pressing the battery power switch and turning on the power again, contact the place of purchase.

■ Troubleshooting

Assist function

Symptom	Cause / Possibility	Remedy
Assistance is not being provided.	Is the battery sufficiently charged?	Check the battery charge. If the battery is nearly spent, recharge it.
	Are you riding on long slopes in summer weather or riding for a long time carrying a heavy load? The battery may be overheating.	Turn off the power, wait for a while and then check once more.
	The drive unit (DU-E6000 / DU-E6001), cycle computer (SC-E6000) or assist switch (SW-E6000) may be connected incorrectly or there may be a problem with one or more of them.	Contact the place of purchase.
	Is the speed too high?	Check the Cycle Computer display. Assistance is not provided at speeds of 25 km/h or more.
Assistance is not being provided.	Are you pedaling?	The bicycle is not a motorbike, so you need to operate the pedals.
	Is the assist mode set to OFF?	Set the assist mode to HIGH. If you still do not feel that assistance is being given, contact the place of purchase.
	Is the power for the cycle computer turned on?	Hold down the power switch to turn on the power. If you still do not feel that assistance is being given, contact the place of purchase.
Assist traveling distance is too short.	The traveling distance may become shorter depending on road conditions, the gear position and whether the light are ON or OFF.	Check the battery charge. If the battery is nearly spent, recharge it.
	The battery characteristics will drop during winter weather.	This is not a sign of a problem.
	The battery is a consumable part. Repeated recharging and long periods of use will cause the battery to deteriorate (lose its performance).	If the distance that can be traveled on a single charge is very short, replace the battery with a new one.
Pedaling is stiff.	Are the tires inflated to a sufficient pressure?	Use a pump to add air.
	Is the assist mode set to OFF?	Set the assist mode to HIGH. If you still do not feel that assistance is being given, contact the place of purchase.
	The battery may be running low.	After charging the battery well, check the level of assistance again. If you still do not feel that assistance is being given, contact the place of purchase.
	Did you turn on the power with your foot placed on the pedal?	Turn on the power again without putting pressure on the pedal. If you still do not feel that assistance is being given, contact the place of purchase.

Battery

Symptom	Cause / Possibility	Remedy
All the five battery level indicators stay on.	The battery level indicators do not show battery levels when the battery is connected to the bicycle. Battery levels are shown during charging.	It is not a sign of a malfunction.
The battery quickly loses its charge.	The battery may be at the end of its service life.	Replace the battery with a new one.
The battery cannot be recharged.	Is the power plug of the charger securely inserted into the electrical outlet?	Disconnect and then reconnect the power plug of the charger, and then repeat the recharging operation. If the battery still cannot be recharged, contact the place of purchase.
	Is the recharging plug of the charger securely inserted into the battery?	Disconnect and then reconnect the recharging plug of the charger, and then repeat the recharging operation. If the battery still cannot be recharged, contact the place of purchase.
	Are the connection terminals of the charger or the battery dirty?	Wipe the connection terminals with a dry cloth to clean them, and then repeat the recharging operation. If the battery still cannot be recharged, contact the place of purchase.
The battery does not start recharging when the charger is connected.	The battery may be at the end of its service life.	Replace the battery with a new one.
The battery and charger are becoming hot.	The temperature of the battery or charger may exceed the operating temperature range.	Stop recharging, wait for a while and then recharge again. If the battery is too hot to touch, it may indicate a problem with the battery. Contact the place of purchase.
The charger is warm.	If the charger is being used continuously to charge batteries, it may become warm.	Wait a while before using the charger again.
The LED on the charger does not illuminate.	Is the recharging plug of the charger securely inserted into the battery?	Check the connection for any foreign objects before reinserting the charging connector. If there is no change, contact the place of purchase.
	Is the battery fully charged?	If the battery is fully charged, the LED on the battery charger turns off, but this is not a malfunction. Disconnect and then reconnect the power plug of the charger, and then repeat the recharging operation. If the LED on the charger still does not illuminate, contact the place of purchase.
The battery cannot be removed.		Contact the place of purchase.
The battery cannot be inserted.		Contact the place of purchase.
Fluid is coming out from the battery.		Contact the place of purchase.
An abnormal odor can be detected.		Stop using the battery immediately and contact the place of purchase.
Smoke is coming out from the battery.		Stop using the battery immediately and contact the place of purchase.

Lights

Symptom	Cause / Possibility	Remedy
The front light or the tail light does not illuminate even when the switch is pressed.	The E-tube Project settings may be wrong.	Contact the place of purchase.

Cycle computer

Symptom	Cause / Possibility	Remedy
The cycle computer display does not appear even when the power switch is pressed.	The amount of battery charge may be insufficient.	Recharge the battery, and then turn the power on once more.
	Is the power turned on?	Hold down the power switch to turn on the power.
	Is the cycle computer correctly installed to the bracket?	Install the cycle computer correctly while referring to "Installing and removing the cycle computer".
	Is the electric wire connector correctly installed?	Check to see if the connector of the electric wire connecting the motor unit to drive unit is not disconnected. If you are not sure, contact the place of purchase.
The gear position is not displayed.	The gear position is only displayed when the power gear shifting unit is installed.	Check if the electric wire connector is disconnected. If you are not sure, contact the place of purchase.
Can the beep be turned off.		Change the setting. Refer to "Beep setting (Beep)".
Can the backlight be turned off.		Change the setting. Refer to "Backlight setting (Backlight)".
The setting menu cannot be launched while riding the bicycle.	The product is designed so that if it detects that the bicycle is being ridden, the Setting menu cannot be launched. This is not a sign of an abnormality.	Stop the bicycle and then make the settings.

Other

Symptom	Cause / Possibility	Remedy
When pressing the switch, two beeps sound, and the switch cannot be operated.	Operation of the switch being pressed has been disabled.	It is not a sign of a malfunction.
Three beeps sound.	An error or warning is occurring.	This occurs when a warning or error is displayed on the cycle computer. Refer to the section "Error messages on the cycle computer" and follow the instructions provided for the appropriate code.
When using an electronic gear shifting mode, I feel that the level of assistance weakens when the gears shift.	This occurs because the level of assistance is being adjusted to the optimum level by the computer control.	It is not a sign of a malfunction.
Sound occurs after gear shifting.		Contact the place of purchase.
A noise can be heard from the rear wheel during normal riding.	Gear shifting adjustment may not have been carried out correctly.	For mechanical gear shifting Adjust the cable tension. For details, refer to the Service Instructions for the derailleur. For powered gear shifting Contact the place of purchase.
When you stop the bicycle, the gear does not shift to the position preset in the start mode.	You may have been pressing the pedals too strongly.	If you press the pedals lightly, the gear shifts more easily.

Key Number

The number that is attached to the key is needed in case you need to purchase spare keys.

Make a note of the in the following box and keep it in a safe place.

Key number

SHIMANO

SHIMANO AMERICAN CORPORATION

One Holland, Irvine, California 92618, U.S.A. Phone: +1-949-951-5003

SHIMANO EUROPE B.V.

Industrieweg 24, 8071 CT Nunspeet, The Netherlands Phone: +31-341-272222

SHIMANO INC.

3-77 Oimatsu-cho, Sakai-ku, Sakai-shi, Osaka 590-8577, Japan

Please note: specifications are subject to change for improvement without notice. (English)

© May 2014 by Shimano Inc. HTR



*Warning! Read this supplement and your cannondale bicycle owner's manual.
Both contain important safety information. Keep both for future reference.*

CANNONDALE EUROPE

*Cycling Sports Group Europe, B.V.
Hanzepoort 27, 7570 GC, Oldenzaal,
Netherlands
(Voice): +41 61 4879380
(Fax): +31 5415 14240
servicedeskeurope@cyclingsportsgroup.com*

CANNONDALE UK

*Cycling Sports Group
Vantage Way, The Fulcrum,
Poole, Dorset, BH12 4NU
(Voice): +44 (0)1202 732288
(Fax): +44 (0)1202 723366
sales@cyclingsportsgroup.co.uk*

WWW.CANNONDALE.COM

*© 2014 Cycling Sports Group
132747 (12/14)*