

HABIT

WHITE PAPER



cannondale®

PROPORTIONAL RESPONSE TECHNICAL SUMMARY

1 Summary

Cannondale believes in creating the perfect ride for all our customers. We aspire to make bikes better and provide a more confident experience for every rider, no matter their size.

Proportional Response is our new design philosophy. It is a distinct approach to bicycle design. By looking at each individual bike size and rider as its own unique system, we can engineer the optimal dynamic response and ride experience for each size rider. In giving that same performance to all size riders, everyone benefits and no one is left behind.

Proportional Response improves the ride experience by providing improved overall pedaling efficiency, ideal braking performance and behavior, regardless of frame size. By varying the frame kinematics by size, we are able to maintain constant anti-rise across the sizes. Leverage ratio rise has also been optimized per size. Larger bikes have received an increased leverage ratio rise, while smaller sizes have received a reduced leverage ratio rise. This allows us to compensate and better match the increased spring forces and air pressures associated with larger, heavier riders.

The new Habit also sees the introduction of a 4-bar linkage suspension platform to Cannondale's mountain bikes. By utilizing a 4-bar linkage we can tailor the anti-rise across the size run, which provides optimal traction under braking. This allows us to maintain the efficient pedaling characteristics that Cannondale is renowned for while also improving performance under braking.

Contents

1 Summary	1
2 Suspension for Mountain Bikes	2
3 Proportional Response	10
4 Experimental Validation of Suspension Response	12
5 Size Specific Kinematics	15
6 A New Suspension Platform	18



2 Suspension for Mountain Bikes

Mountain bike suspension performs three critical functions that define the ride dynamics: 1) Absorb the forces from the terrain; 2) control the bike's chassis behavior during accelerations (both braking and accelerating); 3) define the bike's efficiency and performance.

The primary forces acting on a mountain bike are a) the gravitational force of the bike and rider, b) the inertial forces acting under longitudinal acceleration (braking and accelerating), c) the force from the chain during pedaling, d) the normal forces at the wheel contact patch and e) the acceleration reaction forces at the contact patches. An effective suspension system needs to be able to handle these forces and balance bicycle performance during all riding conditions.

2.1 Weight Transfer

Weight transfer has a strong impact on bicycle dynamics during accelerations, both positive (acceleration) and negative (braking). During braking, weight is transferred toward the front wheel. Consequently, the sprung body of the bike experiences a rotational pitching moment. As the body moves and pitches forward, the result is an extension of the rear suspension and a compression of the front suspension. This forward pitching motion under braking is referred to as dive.

During forward acceleration, the opposite occurs: Weight is transferred rearward, unloading the front wheel and loading the rear wheel. This results in a rearward pitching moment, called squat.

The squat and dive behavior of a mountain bike is a result of the acceleration, the total weight transfer, the spring stiffness of the suspension and the geometric arrangement of the suspension members. The geometric arrangement of suspension is the area that a designer can control in order to provide desired suspension response. Of these, the suspension characteristics that have the greatest impact on the bicycle's dynamic performance are anti-rise, anti-squat, leverage ratio and pedal kickback.

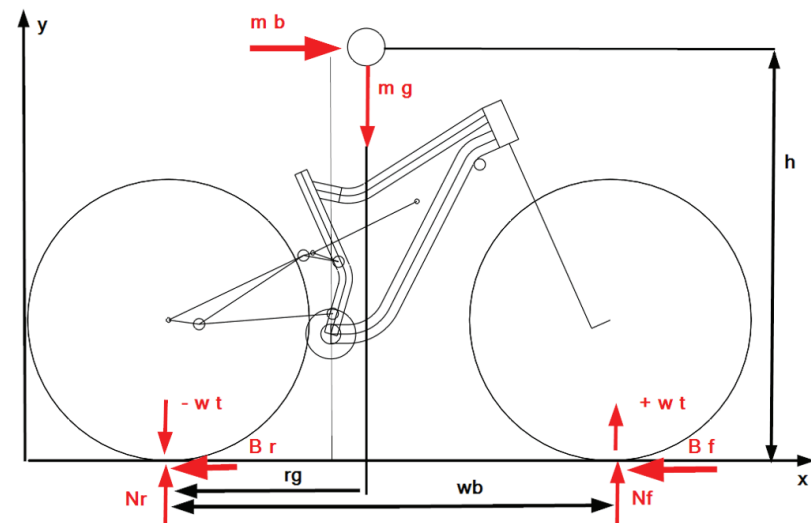

Figure 1 - Graphical representation of weight transfer during braking.

2.2 Anti-Rise

Anti-rise is a metric associated with braking performance. It is defined by the geometric arrangement of the suspension members that balance the moments and forces of a mountain bike during deceleration. By manipulating the arrangement of suspension members, the forces acting on the suspension springs can be reduced, which results in decreased pitching (dive) of the frame caused by weight transfer.

When braking, the important forces acting on the bike are the inertia of the decelerating body and the tractive forces at the wheel contact patches. During deceleration, the resultant force line is defined as the line through the rear contact patch and the swingarm pivot point, as this pivot point is where the forces are transferred to the frame. The location at which the resultant force line crosses a vertical line from the front contact patch (vertical reaction line) is key in defining the anti-rise of the suspension. The ratio of the height of the resultant force line to the center-of-gravity height is the anti-rise. Anti-rise values above 100% cause the suspension to compress under braking. Values below 100% allow the frame to pitch forward, resulting in the rear suspension extending under braking. Anti-rise values less than 100% typically result in better suspension response under braking. See Figure 2.

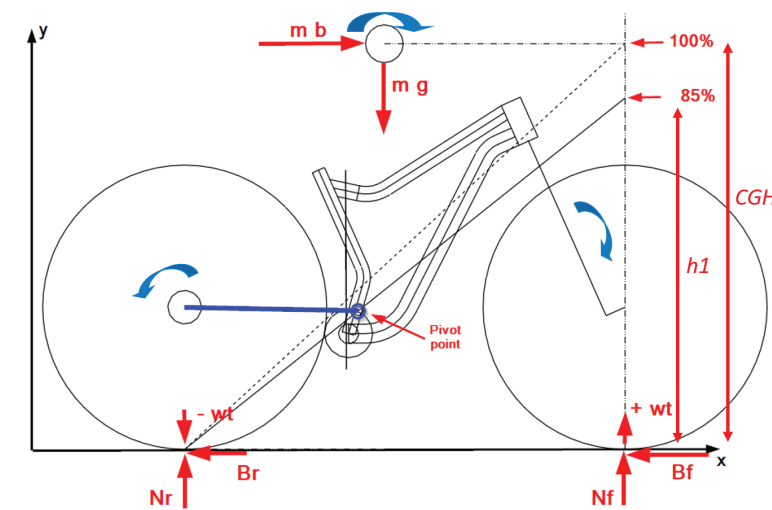

Figure 2 - Representation of anti-rise. The resultant force line in this layout results in anti-rise of 85%.

Through extensive testing we have found that optimum braking occurs at anti-rise values in the range of 40-65% with the suspension at sag. Desired anti-rise can vary by application. For example, cross country and downhill have differing loads and suspension requirements. Anti-rise values in this range ensure the bike's behavior under braking is more consistent, whether braking with the rear brake only or applying both the rear and front brakes simultaneously. This reduces the pitching moment of the frame and permits the rear wheel to extend. The right amount of extension helps the rear wheel maintain contact with the ground for greater traction during braking. In this extension state the rear suspension remains active at a reduced wheel rate, which increases the bump absorption capacity and reduces the bump forces transmitted to the rider.

2.3 Anti-Squat

Anti-squat is typically associated with pedaling performance. It is defined by the geometric arrangement of the suspension members that balance the moments and forces during forward acceleration. The anti-squat and resulting chassis behavior can be solved for, graphically, similar to anti-rise. First, project a line through the bike chainline. Second, project a line through the rear axle and pivot point (PP) along the length of the swingarm. The intersection of these lines is the instantaneous force center (IFC). This is the point through which both the tractive and chain drive forces are transmitted to the bike. For chain driven acceleration, the resultant force line is projected from the rear contact patch, through the IFC, to the vertical from the front contact patch. The intercept between the resultant force line and the vertical, through the front contact patch, characterizes the anti-squat behavior. Anti-squat is defined as the ratio of the height of the resultant force intercept with the vertical to the center of gravity height (weight transfer line). If the resultant force line intersects the vertical at the height of the center of gravity, then the suspension has 100% anti-squat and the net pitching motion about the chassis is zero. When the resultant force line intersects below the center-of-gravity height, anti-squat is less than 100%, and there is a pitching moment about the chassis, which places the rear suspension in extension. It is important to note that the anti-squat changes through the suspension travel and as a function of gear ratio. Furthermore, anti-squat does not change the acceleration of the bike; it defines the pitching behavior of the frame and the reaction of the rear suspension in either compression or extension. See **Figure 3**.

We have found that anti-squat values in the range of 70-90% (depending on platform requirements; e.g. XC vs DH) at sag provide the optimum pedaling characteristics across the entire cassette. This provides sufficient resistance to weight-transfer forces, which results in reduced suspension compression (bobbing) during pedaling. This delivers a high level of pedaling efficiency and consistent suspension behavior. By maintaining anti-squat levels slightly below 100%, the rear wheel is able to track more easily over terrain when the rider is pedaling in technical sections. Maintaining anti-squat levels slightly below 100% also reduces pedal kickback. Both of these positive benefits increase grip in low traction conditions.

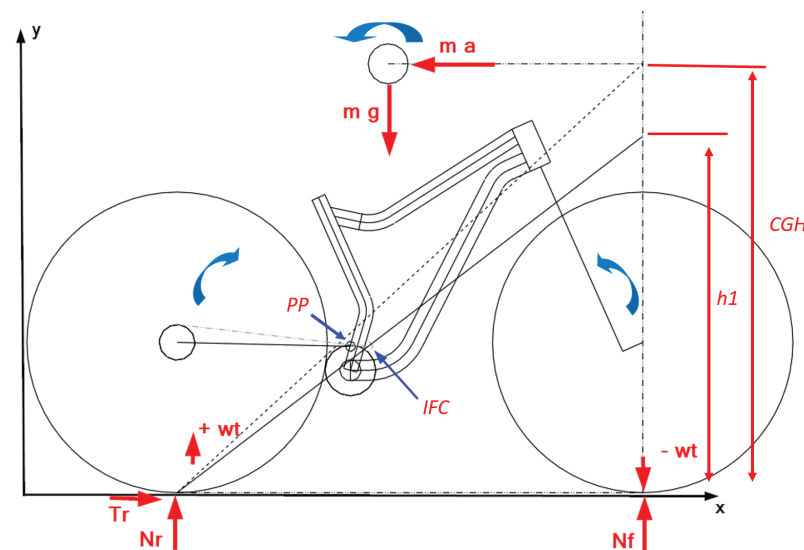

Figure 3 - Representation of anti-squat, showing anti-squat less than 100%. Changes to the suspension geometry drive the angle of the resultant force line and subsequently the anti-squat.

2.4 Leverage Ratio

In bicycle suspension, weight and packaging constraints do not allow for spring and damper assemblies to be mounted directly to the rear axle. Shocks tend to be positioned inside the front triangle and attached to the rear suspension at the swingarm or via mechanical linkage. The mechanical advantage between the rear wheel's displacement and the shock compression is the leverage ratio.

Leverage ratio determines the spring rate at the rear wheel, the wheel rate, and the change in wheel rate as the suspension compresses. There are three general classifications of leverage ratio extensively used in mountain bike suspension: linear, progressive and digressive rates. **Figure 4** displays examples of the three different classes of leverage ratio as a function of travel for a 130mm bike.

A linear rate means that the leverage ratio remains constant through the suspension travel. This makes stiffness at the wheel equal at the beginning and end of the travel. A digressive rate means that the suspension stiffness decreases through the travel. Single pivot bikes with the shock mounted directly to the swingarm tend to have a digressive leverage ratio. A progressive rate means that the suspension becomes stiffer as travel increases. Through our extensive testing we have found that a progressive leverage curve performs better on the trail; the softer stiffness in early travel provides good sensitivity to small bumps, with improved support through the middle and ramped up stiffness to resist bottom out at the end of the travel.

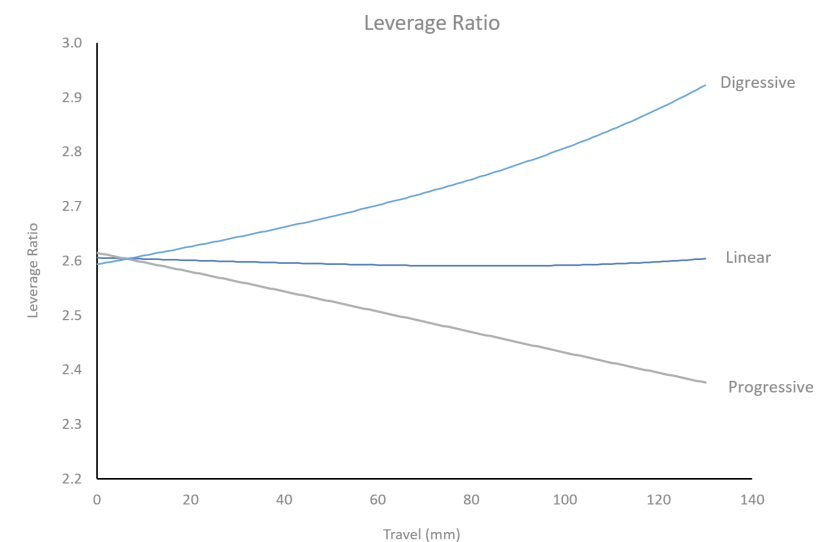

Figure 4 - Three categories of leverage ratio; showing leverage ratio as a function of travel.

2.5 Pedal Kickback

Pedal kickback, or pedal feedback, is a characteristic unique to full-suspension mountain bikes. Typically, as the rear suspension moves through its travel the rear wheel moves away from the bottom bracket. This increases the chain length between the front chainring and the rear sprocket. The growth in chain length introduces pedal kickback since the chain growth effectively causes counter clockwise rotation of the cranks and pedals. This is felt by the rider as a reverse pedal torque against the leading foot. Pedal kickback is typically measured in degrees. This behavior is illustrated in **Figure 5**, below.

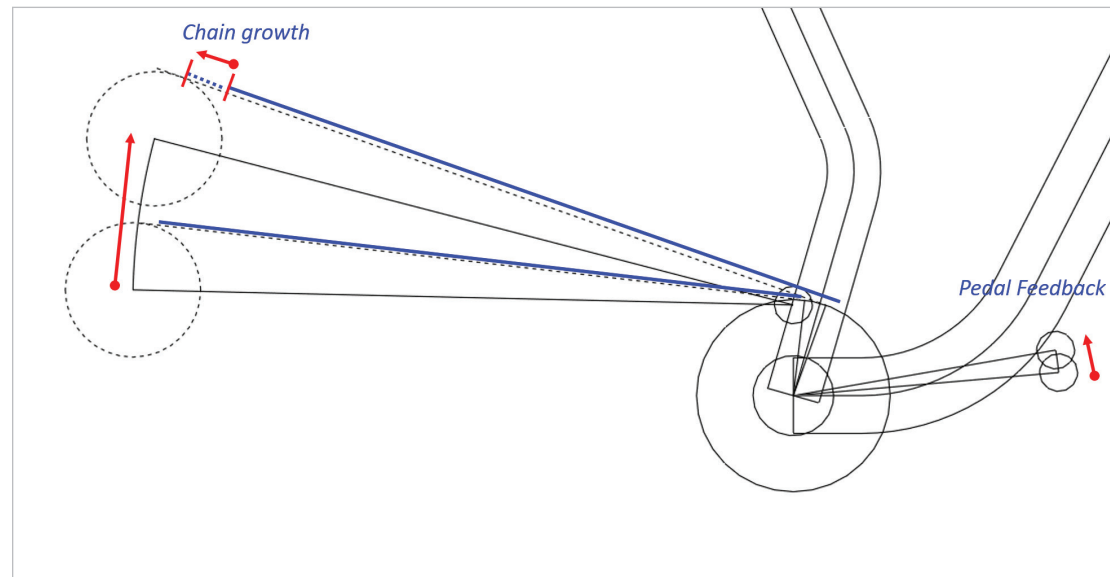

Figure 5 - The motion of the rear wheel away from the BB through the suspension travel creates chain growth, which introduces kickback at the crank and pedals.

The location of the pivot point is the primary driver in defining the motion of the rear wheel relative to the bottom bracket and the growth of the chain relative to its initial length, as well as the rate of change in length. Larger rear sprockets and smaller front chainrings tend to increase pedal feedback. Under rapid rear suspension displacement, forces are transmitted to the rider's feet through the pedals. These forces create instability, discomfort, and can reduce control. Pedal kickback is most apparent during suspension movement over fast repeated bumps, deep suspension compressions, and particularly when braking in rough terrain. One of our design goals for all mountain bikes is to minimize kickback across the entire cassette range to improve climbing traction, braking performance and ride comfort.

2.6 Common Suspension Platforms

2.6.1 Single Pivot

In a single pivot layout, the rear wheel is directly connected to the swingarm. The swingarm being a single member connected to the front triangle at the pivot point. The rear axle path, therefore, has pure rotational motion, which is defined by the swingarm length and the position of the pivot point on the front triangle.

Single pivot platforms are straightforward to design and manufacture. They can be configured to exhibit excellent pedaling efficiency or reduced pedal feedback, but not both simultaneously. They also provide very predictable ride characteristics. However, single-pivot designs have limitations in the braking performance they can achieve. This is dictated by the location of the main pivot location, which is usually defined for pedaling performance. The simple arc motion of the axle cannot be manipulated to reduce chain growth and pedal kickback values in the same way as more complex linkages. The result is a trade-off between braking performance and pedal efficiency. See **Figure 6**.

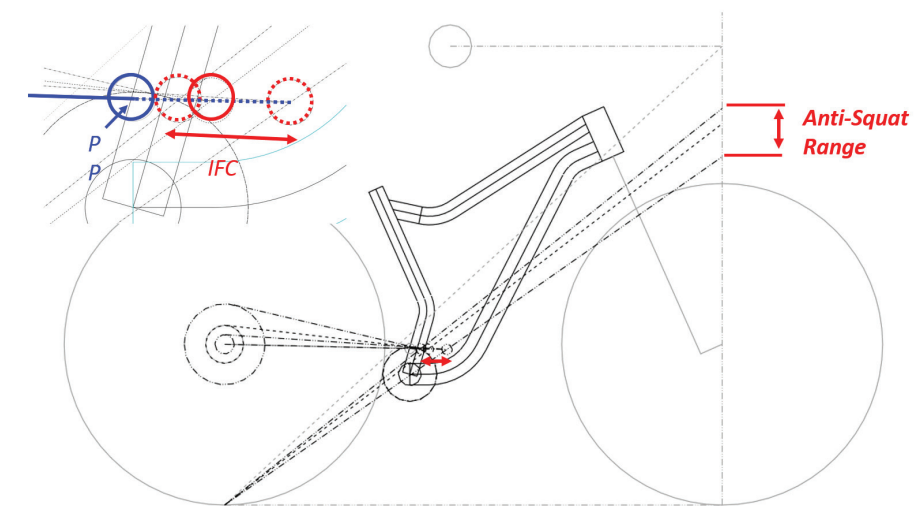

Figure 6 - Representation of single pivot suspension layout, showing changes in anti-squat across the gear ratios.

2.6.2 4-bar Linkage

The 4-bar suspension linkage has been successfully and extensively used in both motorsport and automotive industries over the past half century. This is with good reason, as the additional degrees of freedom give the design engineer greater control over the suspension characteristics that is not possible with a single pivot layout.

The 4-bar suspension is a multi-link mechanism comprising of 4 links, as the name suggests. Most 4-bars have the following four links: front triangle (rigid link), an upper link, a lower link, and a floating link. In this layout the frame acts as the rigid link. The upper and lower links are connected to the frame at their front ends, and their rear ends are connected by the floating link. **Figure 7** depicts a typical 4-bar suspension layout. In this configuration the wheel assembly is mounted to the floating link. Both the upper and lower links rotate about their pivots on the main frame. The combined translation and rotation of the floating link is then defined by the relative rotation, length, orientation and separation of the upper and lower links. **Figure 7** depicts a closed 4-bar linkage, which would be described as a clockwise system, since both the upper and lower links rotate in the same direction.

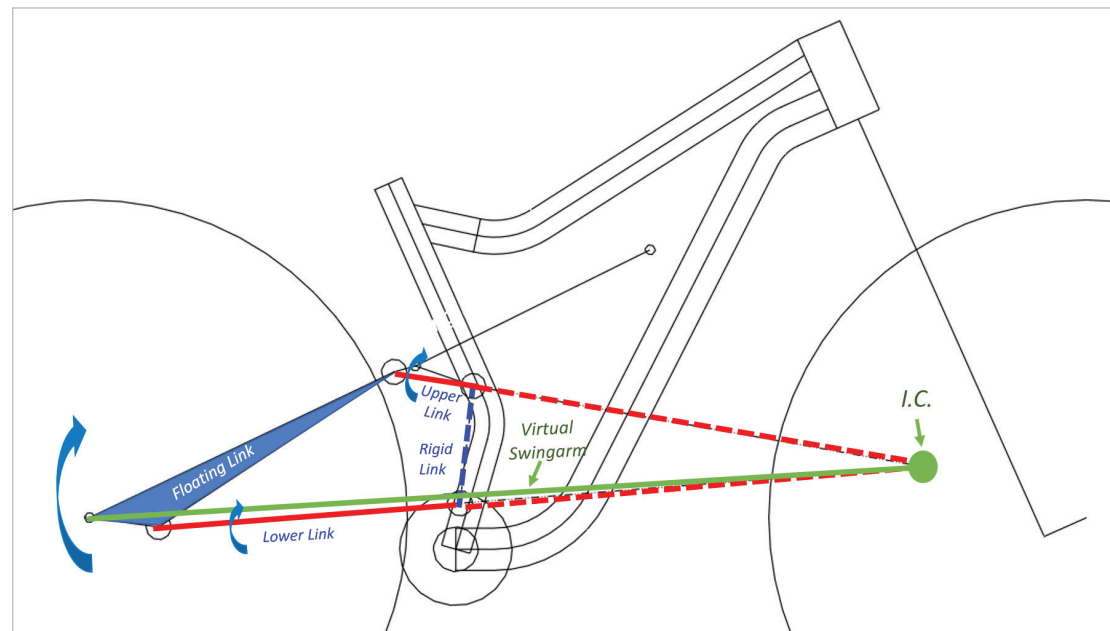

Figure 7 - A typical application of a 4-bar linkage to mountain bike suspension.

Mounting the wheel assembly to the floating link of a 4-bar system means that the instant center (pivot) is not a fixed point as it is on a single pivot design. This allows the design engineer to position the instant center at a virtual point in space, chosen to achieve the desired braking and pedaling characteristics. It also offers the ability to tune the axle path to reduce the effects of chain length growth and pedal kickback. However, this makes a 4-bar system more complicated, as careful attention must be paid to all aspects of the kinematics to ensure balanced performance.

2.7 Disproportional Response

Current mountain bikes, regardless of suspension layout, are typically designed around a single frame size. The kinematics are optimized for this one frame size. Geometries are also typically optimized around this one size. While this provides the desired response for riders of the middle size, large or small riders may not experience the same optimized suspension kinematics.

The center of gravity location varies across the size range due to the different body dimensions and positions of the riders. Our testing has revealed that there is not a linear relationship between the center of gravity height and the front center dimension of the bike. Since the front-center typically varies linearly with size, this causes the anti-rise and anti-squat values to vary across the size range. As frame size increases, this effect results in reduced anti-squat, which decreases pedaling efficiency. It also reduces the anti-rise, which can improve braking performance, depending on the initial value. The opposite is true for small sizes. As frame and rider size decreases, there is an increase in anti-squat, which improves pedaling efficiency. It also increases the anti-rise, which can decrease braking performance. In this case, both larger and smaller riders' suspension performance is compromised. See **Figure 8**.

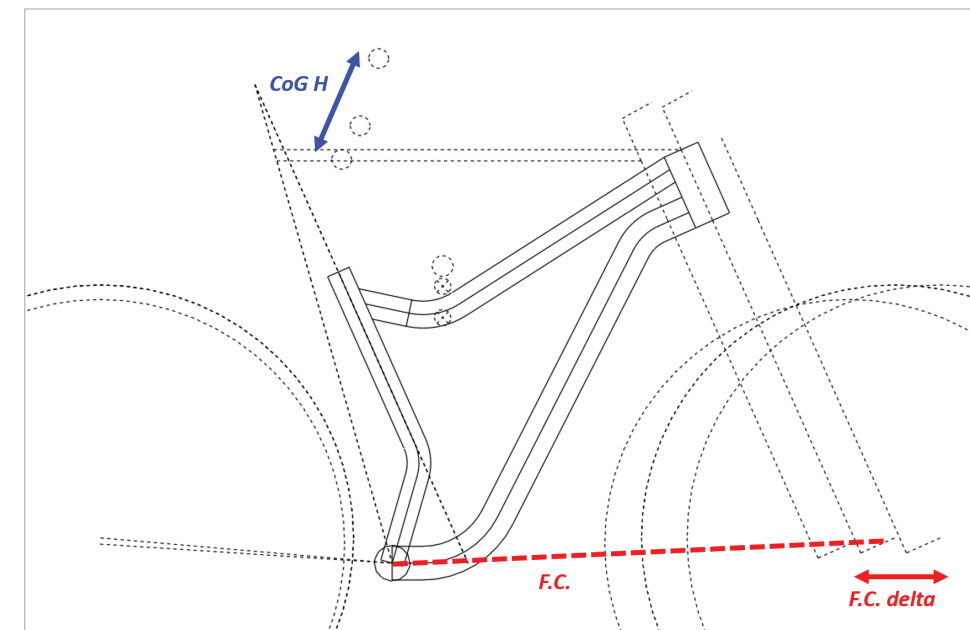

Figure 8 - Representation of the linear change in length of the front center for three frame sizes, and the non-linear change in height of the CoG (indicated CoG heights are not to scale - for illustration purposes only).

3 Proportional Response

Our aim with Proportional Response is to address this discrepancy so that riders of all sizes can benefit from optimized suspension performance. This was achieved by engineering the ideal kinematic response in braking, pedaling, and leverage ratio for each frame and rider size independently.

Utilizing the 4-bar suspension layout, we can achieve the desired anti-rise and anti-squat characteristics for each individual frame size of the new Cannondale Habit. **Figure 9** shows the change in anti-rise with frame size. For the new Habit with Proportional Response the anti-rise at sag is constant. **Figure 10** shows that across the gear range anti-squat maintains high levels for efficient pedaling.

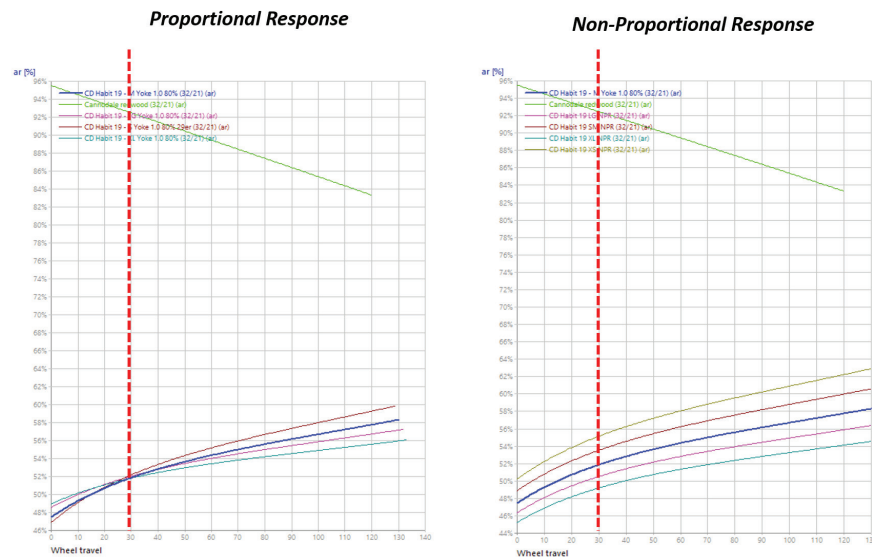

Figure 9 - Plot of the anti-rise values, proportional vs. non-proportional response. With Proportional Response anti-rise varies less across the size range (indicated by different colored series).

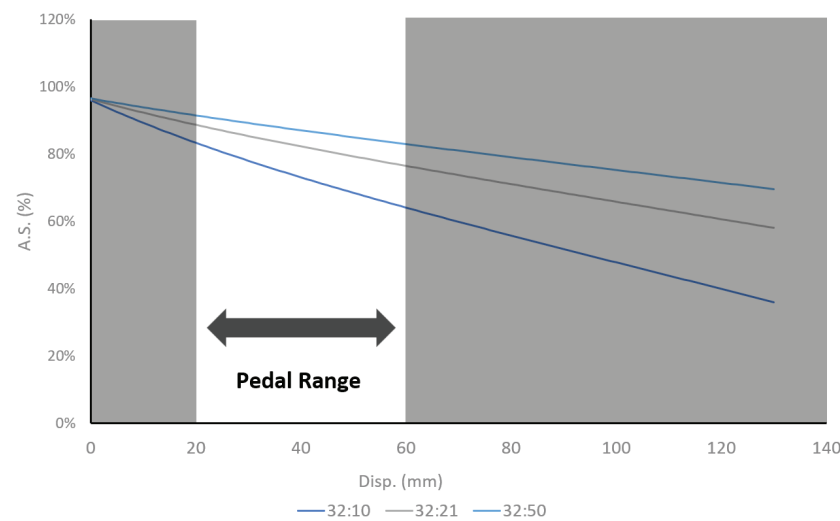

Figure 10 -Plot of the anti-squat values across the gear range for a size medium with 32T chainring. Series indicate gear ratio (Front:Rear).

The new Habit also benefits from a size-specific leverage ratio rise. This was achieved by

adjusting the linkages and shock angles to compensate for different rider masses and resultant forces at the shocks. This provides all rider sizes with the optimal wheel rate and keeps the setup air spring pressures in the ideal range. **Figure 11** shows the leverage ratio curves for each size of the new Habit.

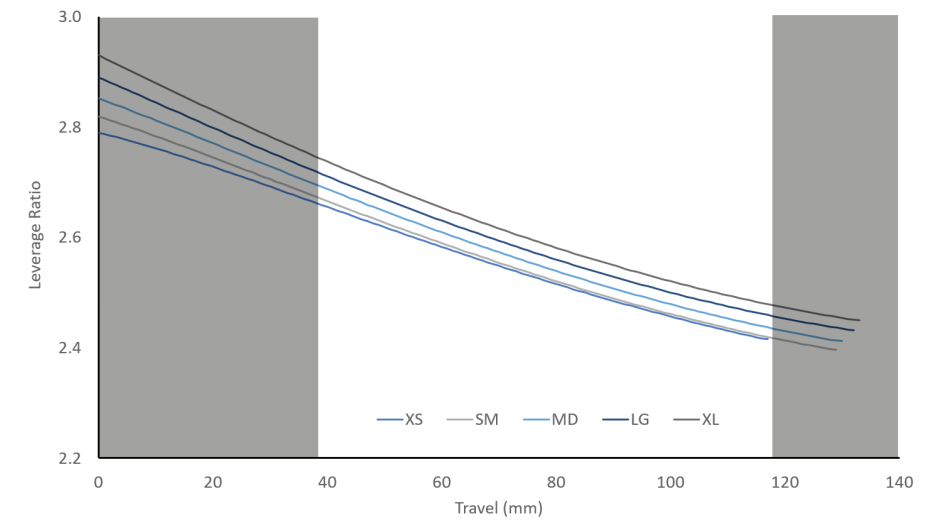

Figure 11 - Representation of the leverage ratio, all sizes. Leverage ratio increases across the size range.

Proportional Response delivers consistent dynamic response from each frame size—for riders of all sizes. It provides a unique blend of intuitive braking performance with improved traction and control for all sizes. It balances pedal efficiency with low pedal kickback and consistent pedaling behavior in all possible gear combinations. The tailored leverage ratio rises of Proportional Response also provide improved small bump sensitivity, mid travel support and seamless bottom-out suspension across all frame sizes.

The new Habit provides all riders with improved grip, control, balance, stability and maneuverability. With Proportional Response, small and large riders no longer sacrifice performance compared to a middle-sized rider. Now, riders of all sizes can enjoy identical optimized dynamic response because we engineered them to ride and feel the same. As a rider, you can ride faster, push harder, carve turns and brake harder with more traction and control. It provides an intuitive ride quality that lets you forget about the bike and focus on the ride.

4 Experimental Validation of Suspension Response

At Cannondale we conduct extensive research across our platforms to ensure that we are delivering our riders with the perfect bikes for their ride. In developing Proportional Response, we identified that braking performance was a critical area that could deliver significant gains in mountain bike performance for different sized riders. Numerous experiments were conducted to gather field data and validate our kinematic models. Vehicle dynamics were studied using a wide range of bicycle telemetry including multi-axis accelerometers, gyroscopes, brake pressure sensors, and speed traps with on-course timing gates.

4.1 Steady State Testing

Steady state testing was used to identify and map the center of gravity height for riders of different sizes under both braking and pedaling scenarios. We were also able to validate our models for anti-squat and anti-rise from the dynamic response of the bikes under both braking and pedaling. Using this validated data for center of gravity height and dynamic anti-rise and anti-squat, we can accurately predict, engineer and optimize the bike's response for optimal braking and pedaling.

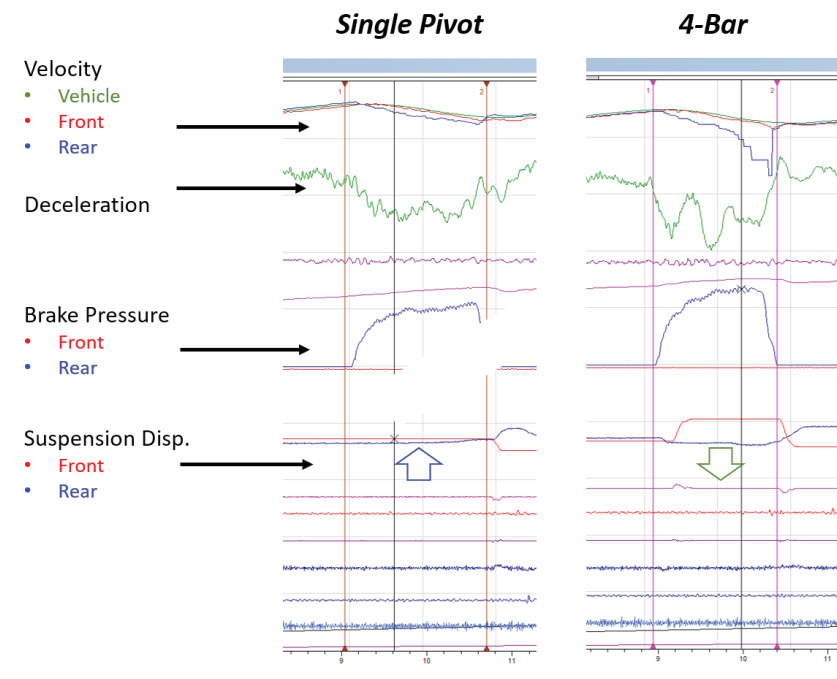

Figure 12 - Representation of the rear suspension behavior in braking, rear brake only, single pivot vs 4-bar. Note that the 4-bar permits greater deceleration and brake force.

4.2 Active Suspension Under Braking

Experiments were conducted to investigate the dynamic response of rear suspension under braking and its effect on traction. Initial testing specifically compared a single pivot design (anti-rise = 100%) to a 4-bar linkage (anti-rise = 50-60%). Telemetry data showed that both suspension platforms were active during braking and able to track over bumps and holes under brake loads. However, the lower anti-rise of the 4-bar linkage provided improved braking performance and traction. It also demonstrated improved control upon rear wheel lockup during hard and abrupt brake applications.

On the 4-bar linkage, the lower anti-rise leads to 20-30% greater extension of the suspension under braking compared to the single pivot. This allows the rear suspension to operate in a lower part of the travel, which provides a suppler ride and improved traction compared to the single pivot. See **Figure 12**. This permits the suspension to better isolate the frame and rider from the forces generated when braking over rough terrain. Therefore, the lower anti-rise setup reduces vertical accelerations transmitted to the frame and improves ride comfort and reduces fatigue.

Further testing of bikes with the chain removed showed that eliminating pedal kickback had a positive impact on braking performance. This reduced the forces transmitted to the frame and pedals as well as reduced the settling time of the suspension after moving over obstacles during braking. The results demonstrate the advantage of reduced pedal kickback in a suspension design. The rider experiences reduced force feedback through the pedals, reduced fatigue, and improved bike control during braking.



Figure 13 - Prototype in testing.

4.3 Better Braking for Higher Speed

Several experiments were designed to specifically compare the performance benefits of the lower anti-rise 4-bar system against the single pivot design. A timing gate speed trap was used to precisely measure performance against the clock over a controlled course. Braking duration and speed were compared to determine if lower anti-rise provides a faster ride through improved braking performance.

In all test conditions the 4-bar suspension outperformed the single pivot configuration. The lower anti-rise produced higher decelerations during braking with both front and rear brakes; 20% higher than the single pivot. When only the rear brake was applied (as a control condition) the difference in deceleration increased up to 25%. See **Figure 14**.

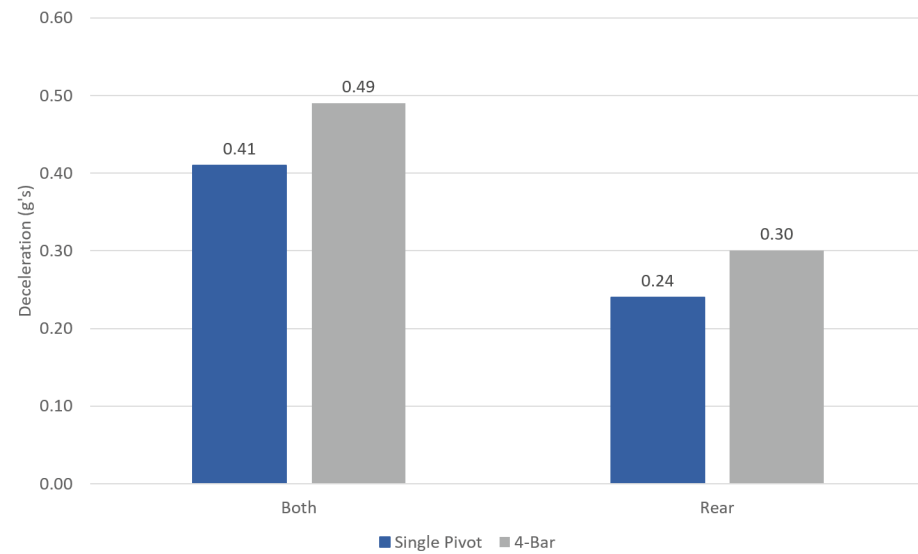

Figure 14 - Deceleration achieved during testing by suspension platform.

When braking and cornering were combined, the 4-bar setup delivered higher average corner speed compared to the single pivot. See **Figure 15**. The lower anti-rise configuration demonstrated improved control when cornering and braking simultaneously. In all cases the reduced anti-rise setup provided greater control and more speed. Feedback from our test riders during experiments also favored the lower anti-rise setup, regardless of rider size or weight.

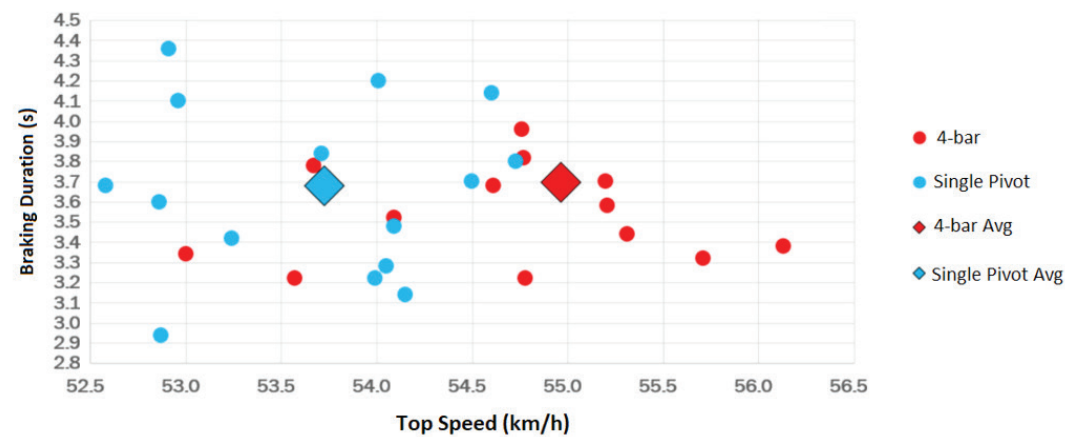

Figure 15 - Plot of top speed and braking duration for the 4-bar and Single Pivot suspension systems. Diamonds indicate average of the set.

5 Size Specific Kinematics

We mapped the mechanical behavior of the suspension system under various loading conditions using advanced vehicle dynamic analysis. At the heart of vehicle dynamics is the Center of Gravity (CoG). The CoG represents the vehicle's mass and location in space. It is at this point that all rectilinear, angular, and rotational forces are considered to act on the vehicle. At the CoG of a vehicle, all components are idealized as moving together as single concentrated mass. For example, when a mountain bike is decelerating, all its parts are considered to slow at the same time as a single unit.

We needed to determine the location of the center of gravity to precisely analyze and understand how a mountain bike behaves. Only then could we measure, analyze, and improve its behavior and performance. For our investigation, we treated the mountain bike and rider as a single system, as it is the sum of these two masses and individual CoG's that determine the center of gravity of the system. See **Figure 16**.



Figure 16 - Test rider on instrumented bicycle with approximate centers of gravity shown.

Mountain bikes experience very different dynamics compared to motorized vehicles. The highest percentage of the overall mass and its locations on a bike is dictated by the rider's mass rather than the bike's frame/chassis. The rider's weight contributes over 80% of the overall system weight. For comparison, the same rider's weight on a typical motorcycle is less than 30% of the system weight. The same rider/driver in a small car amounts to less than 10% of the total weight. This means that the relative motion of the rider's center of gravity has a much more significant effect on the dynamics of a bicycle system when compared to other vehicles. It is therefore crucial to bicycle performance that we understand the location of the center of gravity in different riding conditions.

Three critical riding scenarios were identified and the location of the center of gravity mapped for difference sized riders and bikes. These scenarios are generally described as:

- Pedaling - Standing
- Pedaling - Seated
- Braking



Figure 17 - A rider in three critical riding positions; standing pedaling, seated pedaling and braking.

The center of gravity height for braking and the center of gravity height for pedaling are not the same. (See **Figure 17**) In fact, these heights also change across the bike size range, due to the different rider body dimensions and their body positioning. From this we determined that designing the kinematics around a single center of gravity height for all bicycle sizes means, at best, only one size is optimized. Other size riders have a different ride experience and suffer from inferior performance. This led to an in-depth study of the center of gravity location for riders of different height and mass. From this we determined the optimal centers of gravity around which to design different sized bikes.

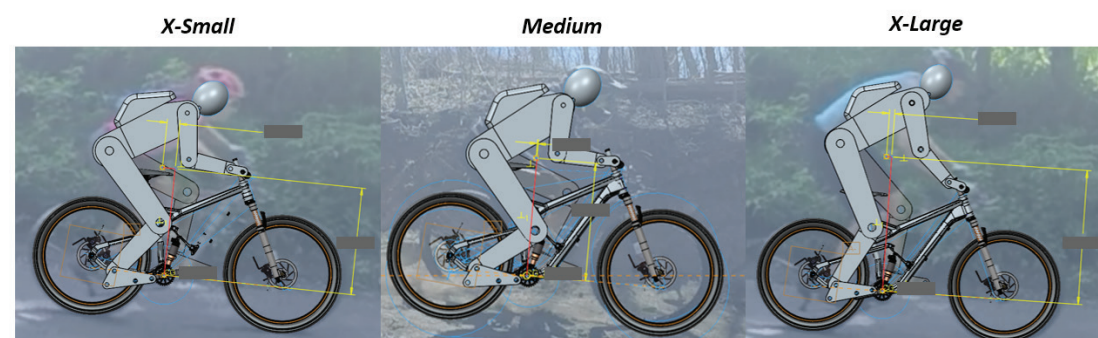

Figure 18 - Images of three different sized riders (XS, Medium and XL) all on the same down slope braking at the same point.

The study showed that the rider's center of gravity height varied significantly between rider size in both braking and pedaling. See **Figure 19**. Based on the resultant centers of gravity for each bike and rider size—in both braking and pedaling scenarios and how these points change—it was apparent that there was room for improvement in the way most mountain bike suspension systems are designed. First, existing design practice typically assumes a constant center of gravity for both braking and pedaling.

Secondly, it is assumed that all riders share the same center of gravity location. Using this knowledge of the differences in center of gravity locations, rather than designing the ideal bike as a size medium, it is now possible to vary the kinematic layout so that every bike and rider size will perform in the same manner.

Commonly, as frame size increases, front center and wheelbase increase linearly. However, the center of gravity height of the rider increases at a higher rate for both pedaling and braking positions. For larger riders, this reduces anti-squat relative to the medium size. This translates to increased suspension displacement (pedal bob) and lower pedaling efficiency. The larger riders also experience lower anti-rise compared to the kinematics of the middle size. On a single-pivot system this improves the braking behavior. However, for bikes with already low anti-rise, the further reduction on larger sizes can produce a larger pitching moment on the frame and higher extension of the rear suspension under braking than desired, potentially limiting negative travel.

For the smaller rider, the opposite is true. The center of gravity height decreases at a higher rate than the reduction in front center and wheelbase. This results in increased anti-squat on smaller frame sizes. This can improve pedaling efficiency if the designed anti-squat is below 100%. Otherwise, it can have the undesired effect of suspension extension under pedaling loads. During braking, the change in center of gravity results in greater anti-rise, which reduces the braking performance.

This behavior illustrates that the suspension performance for larger and smaller riders can be improved by optimizing the suspension kinematics by size, rather than using a single kinematic across the size range. This is Proportional Response.

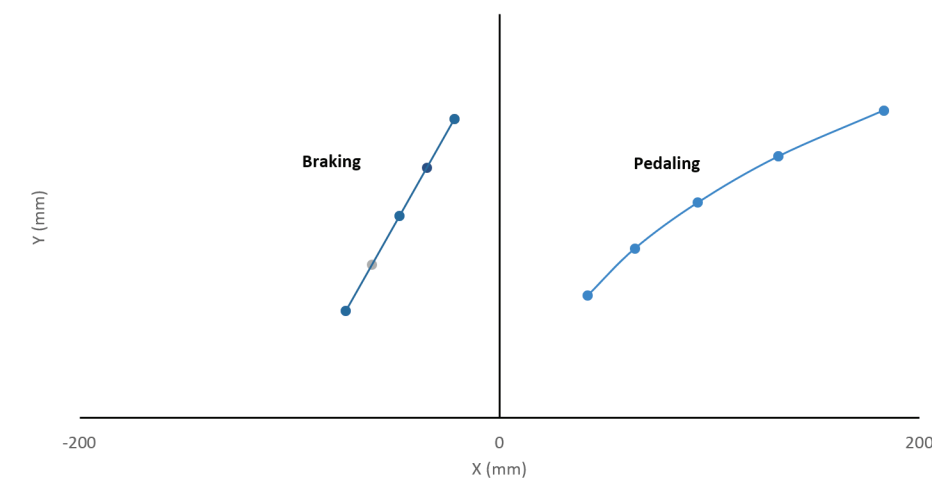

Figure 19 - Location of center of gravity during pedaling and braking by frame size (XS, S, M, L, XL). Origin at BB.

6 A New Suspension Platform

The combination of Proportional Response and our new 4-bar suspension system delivers an improved ride quality based on optimized dynamic behavior and suspension performance, independent of rider size. By reconfiguring the 4-bar linkages for each frame size, and manipulating the instant center, we can optimize the anti-rise and anti-squat response for each size individually. Larger riders no longer suffer from decreased pedaling efficiency, nor smaller riders from poor braking performance. This means we can deliver the perfect ride experience to all our riders, regardless of their size.

The combined system of Proportional Response and the 4-bar linkage suspension represents a completely new way of designing full-suspension mountain bikes. This highly versatile system can be engineered and implemented across a range of suspension travel demands and rider requirements.

Until now, if you didn't ride a size medium, your bike suffered from compromised suspension kinematics. With Proportional Response on the new Habit, all riders can now experience their perfect ride.



